



**ELETTROQUADRI**  
*move the excellence*

# USER, MAINTENANCE AND INSTALLATION MANUAL

**MICROPROCESSOR SYSTEM**

## **MP3**



**TRANSLATION OF THE ORIGINAL INSTRUCTIONS**

ENGLISH

2024- rev. 1.3

REVISION INDEX	REASON FOR REVISION	DATE OF REVISION
1.2	Updated text	14/04/2023
1.3	New logo	02/12/2024

**ELETTROQUADRI S.r.l.**

All rights reserved.

This document may not be reproduced or disclosed even in part in any way. Any violation is punishable by law.

Subject to modification.

The brands and trademarks cited in this manual are the property of the respective manufacturers.



## CONTENTS

- 1 GENERAL INFORMATION.....5**
  - 1.1. Installation Manual.....5
    - 1.1.1. Reproduction limits and copyright .....5
    - 1.1.2. Updates .....5
    - 1.1.3. Care of the instructions.....5
    - 1.1.4. How to print the Instruction Manual .....5
  - 1.2. How to use this manual.....6
    - 1.2.1. Page layout.....6
    - 1.2.2. Symbols .....7
    - 1.2.3. General definitions.....7
  - 1.3. Manufacturer's data .....8
  - 1.4. After-sales assistance .....8
  - 1.5. Warranty .....8
  - 1.6. Testing .....8
- 2 SAFETY .....9**
  - 2.1. Reference standards applied.....9
  - 2.2. Safety warnings .....9
    - 2.2.1. General warnings .....9
    - 2.2.2. Warnings for Installer safety .....9
  - 2.3. Identification of operating personnel.....10
    - 2.3.1. Personal Protective Equipment .....11
  - 2.4. Correct use .....11
  - 2.5. Incorrect use.....11
  - 2.6. Residual risks .....11
- 3 INSTALLATION.....13**
  - 3.1. First connection (tensioning the installation).....13
  - 3.2. Inspection control .....15
  - 3.3. Reset conditions .....16
- 4 PROGRAMMING .....17**
  - 4.1. General warnings .....17
  - 4.2. Programming unit (REMP2 remote terminal) .....18
    - 4.2.1. REMP2 programmer display.....19
  - 4.3. Programming the MP3 board.....20
    - 4.3.1. How to make a call from the control panel .....20
  - 4.4. Further REMP2 programmer functions .....32
    - 4.4.1. LE SELECTION - Fault log reading.....32
    - 4.4.2. Fo selection - Omnibus procedure .....32
    - 4.4.3. EC SELECTION - Travel limit test .....32
    - 4.4.4. In selection - Uncontrolled movement test.....32
- 5 DIAGNOSTICS .....34**
  - 5.1. General warnings .....34
  - 5.2. Fault table and fault finding .....34

<b>6 BOARD FUNCTIONS AND LAYOUT .....</b>	<b>45</b>
6.1. General warnings .....	45
6.2. Necessary Conditions for responding to a call .....	45
6.3. Insulation test.....	46
6.4. Safety chain status check points .....	46
6.5. Switch functions .....	46
6.5.1. UM/DM reed .....	46
6.5.2. RZA / RZB reed switch contacts.....	47
6.5.3. DMS / DMD reed switch contacts .....	47
6.5.4. Slowdown / phase plug control at the top and lowest floors (CRS / CRD) .....	47
6.6. Board technical specifications .....	47
6.6.1. MP3 base board .....	47
6.6.2. MPCAB serial board.....	47
6.6.3. Serial boards in the car and at the floor landings .....	48
6.6.4. ACF board.....	48
6.7. MP3 board lay-out.....	49
6.7.1. LED on MP3 board.....	49
6.8. MPCAB board lay-out .....	50
6.8.1. LEDs on MPCAB board .....	50
6.9. FLSER board lay-out.....	51
6.10. FLDISP board lay-out .....	51
6.11. DSPCOM board lay-out.....	52
6.12. REMP2 layout .....	52
6.12.1. LEDs on REMP2 .....	53
6.13. Manoeuvres .....	54
6.14. Connections for Duplo/Duplex/Triplex/Quadruplex manoeuvres .....	54



# 1 GENERAL INFORMATION

## 1.1. INSTALLATION MANUAL

The Installation manual is an integral part of the board and must be kept with care and accompany the board throughout its entire life cycle, right up to final scrapping.

The manual has been drawn up by the Manufacturer to provide all the necessary information to those authorized to interact with the machine during its expected service life: buyers, installers, expert operators and specialized technicians.

**ELETTROQUADRI S.r.l.** declines all liability for improper use of the board and for damages caused as a result of operations not considered in this manual or in any case unreasonable.

### 1.1.1. REPRODUCTION LIMITS AND COPYRIGHT

Reproduction of the manual, even partial, and distribution by any means, unless expressly authorized by the Manufacturer, is prohibited.

Any unauthorized reproduction will be prosecuted in the manner and times prescribed by the laws in force.

© ALL RIGHTS RESERVED: copyright on this manual belongs to **ELETTROQUADRI S.r.l.**

Reprinting, reproduction and translation, even partial, are prohibited without the written authorization of **ELETTROQUADRI S.r.l.** The manual cannot be transferred to third parties for viewing without the written authorization of **ELETTROQUADRI S.r.l.**

### 1.1.2. UPDATES

Illustrations of the board are provide for explanatory purposes only and are not binding for the Manufacturer. The manufacturer reserves the right to make any changes to components, parts and/or supplies for the purpose of making improvements or for any other reason, without having to update this manual unless said changes alter machine operation and/or safety.



#### **IMPORTANT**

*The Manufacturer reserves the right to make changes without prior notice.*



#### **IMPORTANT**

*Any additions to the manual which the manufacturer deems appropriate to send to users must be kept together with the manual, becoming an integral part thereof.*

### 1.1.3. CARE OF THE INSTRUCTIONS

The Installation manual must be kept by a person responsible for said task, in a suitable place, so that it is always available for consultation in optimum condition.

It must always be easy to find and consulted by the skilled operators and must always accompany the board in the case of transfer or resale.



#### **CAUTION**

*The manual must be kept with care and replaced if it deteriorates and/or becomes illegible.*

### 1.1.4. HOW TO PRINT THE INSTRUCTION MANUAL



#### **CAUTION**

*ELETTROQUADRI S.r.l. shall not be held liable for any misinterpretation of the information contained herein if printing has not been executed correctly.*



## 1.2. HOW TO USE THIS MANUAL

The encharged operators must, under their own responsibility, read this manual carefully before using and programming the board.



### IMPORTANT

Keep this manual for the board's whole life cycle in a known and easily accessible place, so that it is always available when needed.

### 1.2.1. PAGE LAYOUT

The logic applied to the page layout of these instructions is presented and described below.

**2** SICUREZZA

MANUALE DI INSTALLAZIONE, USO E MANUTENZIONE

**3** XXX

**1**

**4**

**IMPORTANTE**  
Gli interventi sulla scheda devono essere effettuati rispettando scrupolosamente le competenze operative. Il fabbricante declina qualsiasi responsabilità in caso di mancato rispetto di tali competenze.

**ATTENZIONE**  
Durante le operazioni l'operatore deve indossare tutti i Dispositivi di Protezione Individuale (DPI) necessari.

**ATTENZIONE**  
L'installatore NON deve mai compiere di propria iniziativa operazioni o manovre non di sua competenza che possano compromettere la salute e la sicurezza propria o di altre persone.

**2.3. IDENTIFICAZIONE DEL PERSONALE OPERATIVO**

Il personale operativo è il personale responsabile incaricato all'installazione, alla progettazione e alla manutenzione in funzione delle specifiche competenze e qualifiche che, in tutti i casi:

- conosce perfettamente le istruzioni di questo documento sul quale è stato specificatamente istruito ed informato;
- ha maturato esperienza e conoscenza nello specifico ambito lavorativo.

Quando uno dei seguenti simboli si trova all'inizio di una pagina o a fianco di un testo specifico di questo documento significa che le operazioni descritte sono di esclusiva competenza di uno specifico operatore. Il simbolo inoltre indica il livello di qualifica richiesto per lo specifico operatore.

**INSTALLATORE**  
Persona con qualifica tecnica specifica e certificata, responsabile per interventi elettrici che in completa autonomia può:

- eseguire operazioni di manutenzione, smontaggio, assistenza, sostituzione e riassetto di parti elettriche o apparati;
- identificare rotture/danneggiamenti elettrici/elettronici e determinare loro cause;
- eseguire operazioni di calibrazione;
- prevedere pericoli derivanti da queste operazioni.

**TECNICO SPECIALIZZATO ELETTROQUADRI**  
Tecnico specializzato incaricato dal fabbricante, idoneo e qualificato ad eseguire le stesse mansioni dell'installatore.

Il Tecnico specializzato è in grado di svolgere attività specifiche (es. meccaniche, elettriche ed elettroniche) escluse dalle competenze o non eseguibili in autonomia dell'utilizzatore (es. supervisione all'installazione, collaudo, regolazioni, ottimizzazioni, etc.). Il fabbricante, se non concordato contrattualmente con l'utilizzatore può comunque garantire, in caso di necessità, l'intervento di un tecnico specializzato attraverso l'assistenza post-vendita.

© ELETTROQUADRI S.r.l.

12 / 70

MP2 - rev. 2.8

**1**

**2** XXX

**3** SICUREZZA

**2**

MANUALE DI INSTALLAZIONE, USO E MANUTENZIONE

**4**

**2.3.1. DISPOSITIVI DI PROTEZIONE INDIVIDUALE**

PITTOGRAMMI	DESCRIZIONE
	OBBLIGATORIO INDOSSARE LE CALZATURE DI SICUREZZA
	OBBLIGATORIO INDOSSARE I GUANTI PROTETTIVI
	OBBLIGATORIO INDOSSARE GLI INDUMENTI PROTETTIVI

**2.4. Uso CORRETTO**

La scheda MP2 DEVE essere utilizzata esclusivamente nei quadri elettrici ELETTROQUADRI S.r.l. per la movimentazione degli ascensori.

**2.5. Uso SCORRETTO**

La scheda NON deve essere utilizzata:

- per usi diversi da quelli descritti nel paragrafo 2.4 "Uso Corretto".

**2.6. RISCHI RESIDUI**

Nonostante siano state osservate le regole di sicurezza e l'uso della scheda avvenga secondo quanto indicato nel presente manuale, sono da segnalare i seguenti rischi residui:

**Rischio residuo di folgorazione**  
Rischio di folgorazione presente in tutte le parti che rimangono in tensione a quadro aperto.

© ELETTROQUADRI S.r.l.

MP2 - rev. 2.8

13 / 70

### Key:

- A. MANUAL HEADING
- B. FOOTNOTES
- 1. Manufacturer's logo
- 2. Board model
- 3. CHAPTER of the Installation Manual section - NUMBER and NAME
- 4. Type of manual
- 5. Board model and manual revision index
- 6. Number corresponding to the current page and total number of pages in the whole manual
- 7. Manufacturer's name and copyright



1. Title	Chapter Title. (1. "Chapter number")
1.1. Title	Heading. (1. "Chap. No." 1. "Heading Number")
1.1.1. Title	Sub-heading. (1. "Chap No." 1. "Heading no." (1. "Sub-heading number")
1. list	Numbered list, for identifying operations in succession.
• list	Bullet points, for general lists.

The references inside the figures may consist of letters (A, B, C ...) or sequential numbers (1, 2, 3 ...). Each figure with a reference may be followed by a **Key** describing the indicated elements.

### 1.2.2. SYMBOLS

For the purpose of highlighting important parts of the text or important specifications, certain symbols have been adopted, the meaning of which is described below.



#### **GENERIC HAZARD**

*Indicates situations of potential danger that, if overlooked, can seriously endanger people's health and safety.*



#### **GENERAL OBLIGATION**

*Indicates information or a precaution that must be observed to avoid operations that may damage the board, or in any case, a part of the text that deserves specific attention.*



#### **IMPORTANT**

*Indicates technical information of particular importance which should not to be overlooked.*



#### **ENVIRONMENTAL NOTE**

*Indicates the obligation to dispose of waste materials in an ecological manner.*



#### **ELECTROCUTION HAZARD**

*Indicates situations of potential danger that can seriously endanger people's health and safety.*

### 1.2.3. GENERAL DEFINITIONS

Some recurring terms in the manual are described to ensure a more complete understanding of their meaning.

**ELETTROQUADRÌ S.r.l.**, the manufacturer of the aforementioned board, will be referred to as the **Manufacturer**.

#### **Danger zone:**

any area inside and/or near the electric cabinet containing the board in which the presence of a person constitutes a risk for the health and safety of said person.

#### **Exposed person:**

any person who is completely or partially inside a danger zone.

#### **Installer:**

Skilled technician for board installing/programming.

**Maintenance personnel:**

Person responsible for servicing and repairing the board.

**REMP2 remote terminal:**

External programming device which connects to the MP3 or MPCAB boards.

## 1.3. MANUFACTURER'S DATA

**ELETTROQUADRI S.r.l.**

Via Puccini, 1  
21050 Bisuschio (VA) - Italy  
Tel. +39 0332 470049 - Fax. + 39 0332 474032  
[www.elettroquadri.net](http://www.elettroquadri.net)

## 1.4. AFTER-SALES ASSISTANCE

For any assistance, contact the Manufacturer's Assistance Service.

**CAUTION**

*The Manufacturer declines all liability for accidents involving persons or things caused by a failure to observe the instructions and regulations provided in this manual or the non-observance of the safety and accident prevention regulations in force in the country of machine use.*

## 1.5. WARRANTY

The MP3 board warranty is valid for 1 year.

**CAUTION**

*The Manufacturer declines all liability for accidents involving persons or things caused by a failure to observe the instructions and regulations provided in this manual or the non-observance of the safety and accident prevention regulations in force in the country of machine use.*

## 1.6. TESTING

The board was tested during the production phases on the manufacturer's premises.





## 2 SAFETY

### 2.1. REFERENCE STANDARDS APPLIED

REFERENCE	TITLE
EN 81-20:2020	Safety rules for the construction and installation of lifts - Lifts for transporting persons and property - Part 20: Lifts for persons and property accompanied by persons
EN 81-50:2020	Safety rules for the construction and installation of lifts - Checks and testing - Part 50: Rules for the design, calculation, checking and testing of lift components
UNI 10411-1:2021	Modifications to electric lifts not conforming with Directive 95/16/EC
UNI 10411-2:2021	Modifications to hydraulic lifts not conforming with Directive 95/16/EC
UNI 10411-3:2016	Modifications to electric lifts installed in conformity with Directive 95/16/EC and UNI EN 81-1
UNI 10411-4:2016	Modifications to hydraulic lifts installed in conformity with Directive 95/16/EC and UNI EN 81-2
UNI 10411-5:2017	Modifications to electric lifts installed in conformity with Directive 95/16/EC or Directive 2014/33/EU and not conforming with UNI EN 81-1
UNI 10411-6:2017	Modifications to hydraulic lifts installed in conformity with Directive 95/16/EC or Directive 2014/33/EU and not conforming with UNI EN 81-2

### 2.2. SAFETY WARNINGS

#### 2.2.1. GENERAL WARNINGS



**CAUTION**

*Consequently, any intervention which alters board configuration shall automatically exonerate the manufacturer from all liability.*

Consequently, any use other than those indicated in this manual shall exonerate **ELETTROQUADRI S.r.l.** from all liability for any risks which may occur.

#### 2.2.2. WARNINGS FOR INSTALLER SAFETY

Before commencing work, the Installer must be fully knowledgeable of board function, configuration, and technical operating characteristics.



**CAUTION**

*Any work to be performed on the board requires maximum caution from the Installer.*



**IMPORTANT**

*Works on the board must be performed in strict observance of operational competences. The Manufacturer declines all liability for any failure to observe said competences.*

**CAUTION**

*During operations the operator must wear all the necessary Personal Protective Equipment (PPE).*

**CAUTION**

*The Installer must NEVER perform operations or manoeuvres on his own initiative which are not within his sphere of competence and may jeopardize his own safety and that of others.*

## 2.3. IDENTIFICATION OF OPERATING PERSONNEL

Operating personnel are the operators employed to perform installation, programming and maintenance activities depending on specific skills and qualifications, who, in all cases:

- are fully familiar with the instructions provided in this document on which they have been specifically trained and instructed;
- have gained sufficient experience and knowledge in the specific field of work.

When one of the following symbols is found at the start of a page or alongside a specific part of the text in this document, it means the operations described are the exclusive competence of a specific operator. The symbol also indicates the level of qualification required for the specific operator in question.

**INSTALLER**

Person with specific and certified technical qualifications responsible for electrical work on the machine who can, in complete autonomy:



- perform maintenance, disassembly, assistance, replacement and reassembly operations on electrical parts and equipment;
- pinpoint failures/electrical damage and determine the cause;
- perform calibration operations;
- envisage hazards deriving from these operations.

**ELETTROQUADRI'S QUALIFIED TECHNICIAN**

Expert technician employed by the manufacturer who is suitable and qualified to perform the same tasks as the Installer.





The Expert Technician is able to perform specific activities (e.g. mechanical, electrical and electronic) not covered by the user's sphere of competence and which therefore cannot be executed autonomously (e.g. supervision of installation, testing, adjustments, optimization, etc.).

The Manufacturer, if stipulated in the contract with the user, may in any case guarantee, if needed, expert technical intervention via the after-sales assistance service.



### 2.3.1. PERSONAL PROTECTIVE EQUIPMENT

PICTOGRAMS	DESCRIPTION
	SAFETY FOOTWEAR MUST BE WORN
	PROTECTIVE GLOVES MUST BE WORN
	PROTECTIVE CLOTHING MUST BE WORN

### 2.4. CORRECT USE

The MP3 board may ONLY be used in electrical lift control cabinets ELETTROQUADRI S.r.l..

### 2.5. INCORRECT USE

The board MUST NOT be used:

- for any uses other than those described in heading 2.4 "Correct use".

### 2.6. RESIDUAL RISKS

Even when the safety regulations and rules of board use are observed as indicated in this manual, the following residual risks need to be noted:



***Residual risk of electrocution***

*Risk of electrocution relating to all parts which remain live when the cabinet is opened.*

---

PAGE LEFT INTENTIONALLY BLANK

---



# 3 INSTALLATION

## 3.1. FIRST CONNECTION (TENSIONING THE INSTALLATION)

To move the platform inside the shaft, before the safety contacts are installed,

→ make the following connections:

- R, S, T, GND, (neutral).
- Hoist motor.
- Rope: brake.
- Variable speed drive: hook the shielded cable up between the enclosure and the hoist motor.
- Hydraulic: solenoid valves.
- Motor thermistors (between the TP and GND terminals).
- For the Commissioning Kit, refer to the wiring diagram for the system in question.



### IMPORTANT

For the numbers of the terminals, refer to the system's wiring diagram.

→ jumper the terminals:

- For RM mini-contactor excitation.

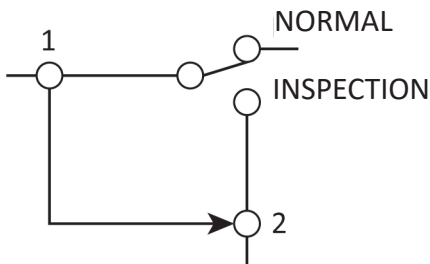

- To bypass the safety chain contacts.  
N.B.: some terminals are optional, if they are not present go to the next terminal.

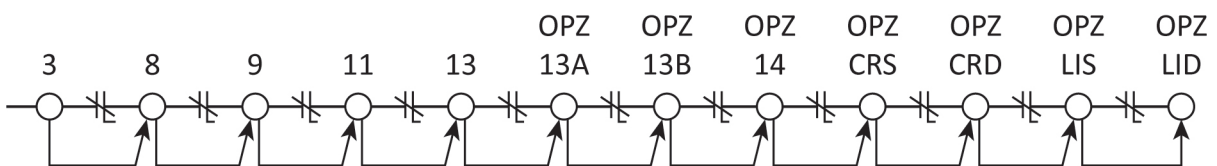

- Optional : 24 VDC bi-stable.

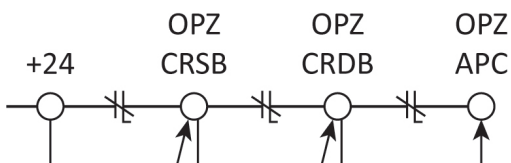

- For moving the car up.

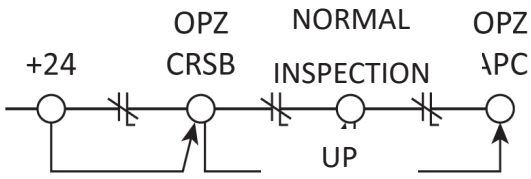

- For moving the car down.

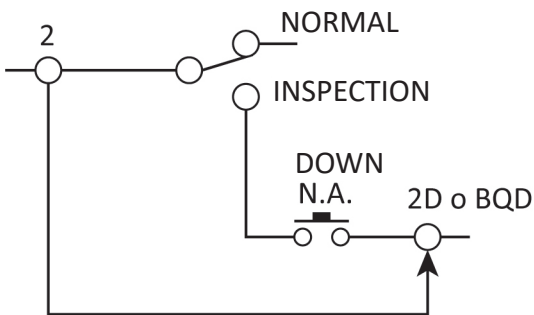

**IMPORTANT**

*For the response to the up/down control, refer to "Inspection control".*



**CAUTION**

*Before putting into operation remove all jumpers previously wired.*



## 3.2. INSPECTION CONTROL

The **inspection control** is activated by setting the switch from “**NOR**” to “**ISP**” position. The **RM** mini-relay is energized and sends the information that inspection control has been activated to terminal **J11/6(RM)** of the board; “**HH**” signal will appear on board display.

**The contactors are controlled by the board** which actuates the control signals received from the inspection control panel:

- Inputs J7/1(▼) and J7/2(▲) receives the control signals from the “**down**” and “**up**” buttons (if both signals are present, no control signal is output).
- The “**down**” and “**up**” buttons, via their diodes, terminal 2A or BSQ/BQD and the RM contact, power the safety chain; the board checks for voltage at input J7/8 (led D3 REMP2) and outputs the close doors signal.
- When full closure of the safety chain is confirmed via the pick-up point at input J7/10 (led D4 REMP2), the slide and contactors are activated.
- Depending on the signals at inputs J7/1(▼) and J7/2(▲) the board activates the high speed+down outputs (GV+D) or high speed+up outputs (GV+S) and monitors their excitation and de-excitation as in normal operation.
- To prevent repeated jog operation in a single direction of travel and immediate reversal of direction, a delay of 1 second has been introduced between the release of a button and the response of the board to the next operation of the same or another direction button.
- The faults indication is also active during the inspection activity.
- The run of the car is limited by CRS and CRD mechanical switches or by bistable CRSB / CRDB switches at the top and bottom floors.
- Once the inspection is completed, the car, if it has been moved, resets to the lowest floor, or to its former destination.

### 3.3. RESET CONDITIONS

In the shaft, the board loses knowledge of the car position under the following conditions:

- Loss of power.
- After inspection control (when the car has been moved).
- When reset button on the board is activated.
- After board programming sequence or timers adjustment.
- When CRS/CRD (or CRSB/CRDB) slowing down commands are activated due to car out-of-step condition.
- After faults where reset to the lowest floor is needed.

The reset sequence will always bring the car to lowest floor; different conditions are possible:

- Car already at the lowest floor (UM/DM led on and CRD or CRDB reset contact open): the reset happens without moving the car.
- Car slightly higher than the lowest floor (CRD or CRDB reset contact open): the car moves down at low speed, and stops when it encounters both magnetic strips at the lowest floor level.
- Car in higher position in the shaft (CRD or CRDB reset contact closed): the car moves down at high speed, and stops when it trips the lower CRD reset contact; it restarts down at low speed, and stops when it encounters both magnetic strips at the lowest floor level.

**IMPORTANT**

*“Continuous reset” (i.e. with stop and restart) can be set with parameter  $t_0$  (see par. 4.4. “Programming the MP3 board”) by entering the car speed (in m/s), positioning the DM slowdown strip at the bottom floor (length 30 cm), and adjusting parameter P6 to delay activation (if necessary).*

- Car slightly lower than lowest floor level (UM led on and CRD or CRDB reset contact open):
  - Hydraulic: the releveling circuit, if separate from the board.
  - Rope: the car moves up direction at low speed and stops when it encounters both the magnetic strips.

**IMPORTANT**

*If the main floor is not the lowest floor, the reset described above will conclude with the car returning to the main floor.*

**IMPORTANT**

*On shaft encoder systems, the system resets at the closest floor.*





# 4 PROGRAMMING

## 4.1. GENERAL WARNINGS



INSTALLER



### CAUTION

*During operations the operator must wear all the necessary Personal Protective Equipment (PPE).*



### RESIDUAL RISK OF ELECTROCUTION

*Risk of electrocution relating to all parts which remain live when the cabinet is opened.*



### IMPORTANT

*The Manufacturer declines all liability for operations performed:*

- *by inadequate personnel;*
- *without observing the health and safety regulations in force;*
- *without observing the procedures provided in these instructions.*



### IMPORTANT

*Before performing any procedure make sure you have read and understood all the various steps, seen all the relative images and adopted the safety and protection measures described.*

## 4.2. PROGRAMMING UNIT (REMP2 REMOTE TERMINAL)

The REMP2 remote terminal is an external programmer which connects to the MP3 board (connector J4) or MPCAB board (connector J4).

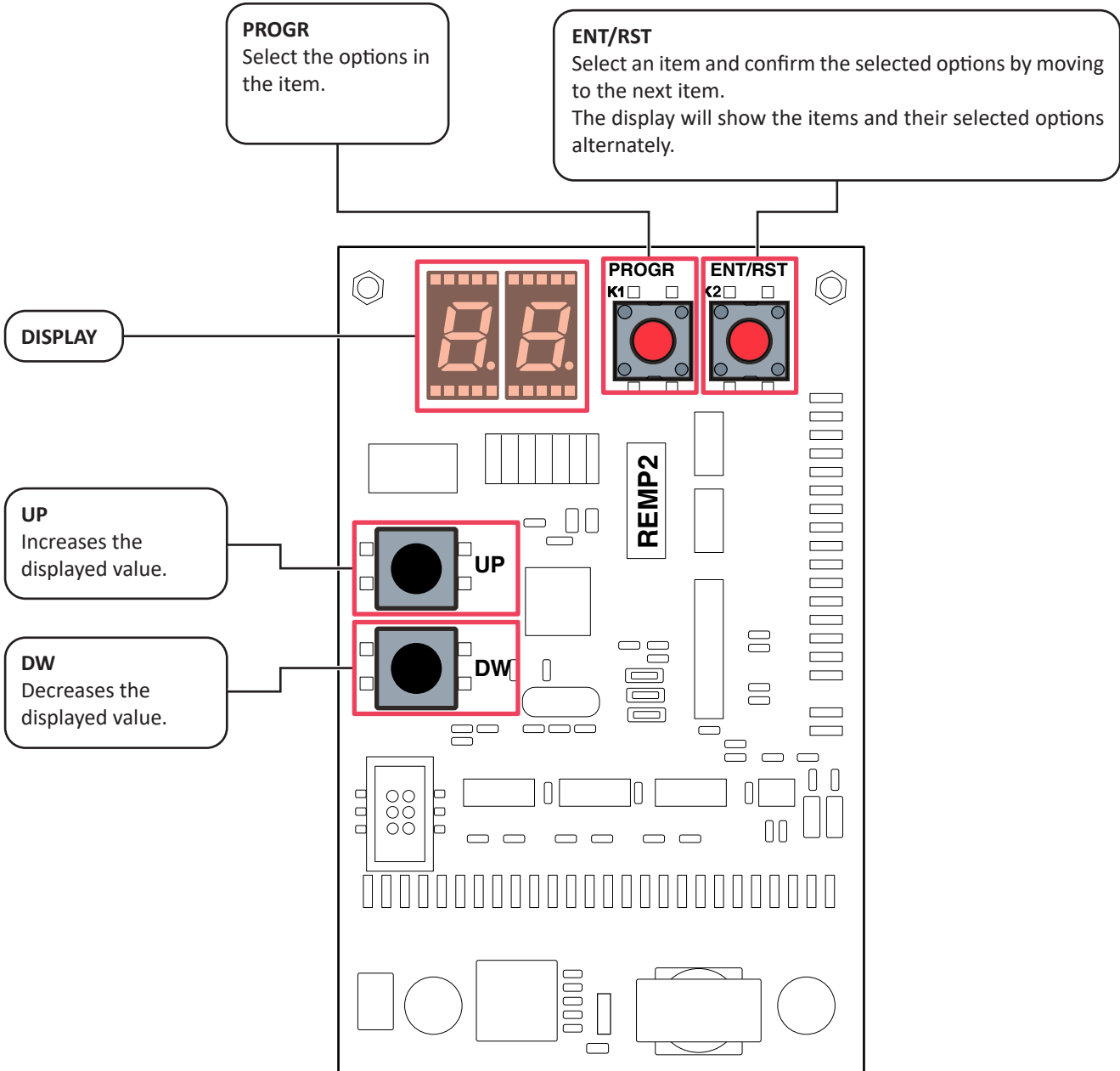



## 4.2.1. REMP2 PROGRAMMER DISPLAY

Indication on the display	Description
	Program release version (e.g. "r51"); displays on power up.
	System resetting.
	Floor position indicator (e.g. "-1").
	Combination of letters and numbers for programming the board, timers and other variables and functions. See par. "4.4. PROGRAMMING THE MP3 BOARD".
	Error message. See par. "5.2. FAULT TABLE AND FAULT FINDING".
	Inspection manoeuvre in progress.
	<b>Programming mode</b> P <sub>b</sub> → R <sub>C</sub> : <ul style="list-style-type: none"> <li>front access only.</li> </ul>
	<b>Programming mode</b> P <sub>b</sub> → R <sub>C</sub> : <ul style="list-style-type: none"> <li>rear access only.</li> </ul>
	<b>Programming mode</b> P <sub>b</sub> → R <sub>C</sub> : <ul style="list-style-type: none"> <li>both accesses.</li> </ul>
	<b>Programming mode</b> P <sub>S</sub> : <ul style="list-style-type: none"> <li>duplo/duplex/triplex/quadruplex: floors not served.</li> </ul>
	<b>Normal operation</b> , actuation: <ul style="list-style-type: none"> <li>of a car call button.</li> <li>of a floor call button.</li> </ul>
	<b>Normal operation</b> , actuation: <ul style="list-style-type: none"> <li>of the door open button.</li> <li>of the photocells or mobile rib.</li> <li>of the overload.</li> <li>of machine room temperature.</li> </ul>

### 4.3. PROGRAMMING THE MP3 BOARD

The following keys on the REMP2 are used for programming: **PROGR**, **ENT/RST**, **UP**, **DW**.

There are three ways to access it:

- after opening the automatic valve **VA** (always present in the electrical cabinet);
- after opening the safety chain switch **IM** (optional);
- via inspection of the manoeuvre cabinet (optional).

For example: **open the automatic valve VA**, then hold down **PROGR** and after 1 second press the key **ENT/RST** 4 times: this opens the **MAIN MENU** (the displays shows SP and the program code alternately).



#### IMPORTANT

*To quit programming, simply close the automatic valve VA at any time.*



#### IMPORTANT

*Reset the board by holding the "RESET" button down for 5 sec.*



#### IMPORTANT

*The programmed data MUST be confirmed with ENT/RST.*



PROGR

Press **PROGR** to change program/move the dot.



ENT/RST

Press **ENT/RST** to enter the selected program/confirm the setting.



UP / DW

Press **UP** or **DW** to select the floor. **UP** increments numerical values. **DW** decrements numerical values.

#### 4.3.1. HOW TO MAKE A CALL FROM THE CONTROL PANEL

Press **UP** and **DW** together, the display will start flashing (and display the lowest floor).

Select the floor you wish to call with **UP** and **DW**. Press **ENT/RST** to confirm and make the call.



MAIN MENU					
Codes		Values	Meaning	Description	
SP		P <sub>b</sub>	Basic programming	Programming menu elements	
		P <sub>t</sub>	Time programming		
		P <sub>o</sub>	Option programming		
		P <sub>L</sub>	Light signal programming		
		LE	read fault log (see par. 4.5.1)		
		SS	special procedures		
		└	F <sub>o</sub>		omnibus operation (see par. 4.5.2)
			E <sub>c</sub>		travel limit test (see par. 4.5.3)
			I <sub>n</sub>		uncontrolled movement test (see par. 4.5.4)
			P <sub>R</sub>		first start up
P <sub>n</sub>	marine procedure (see wiring diagram)				
	nu	quit SS menu			
FP		Programming end			



**IMPORTANT**

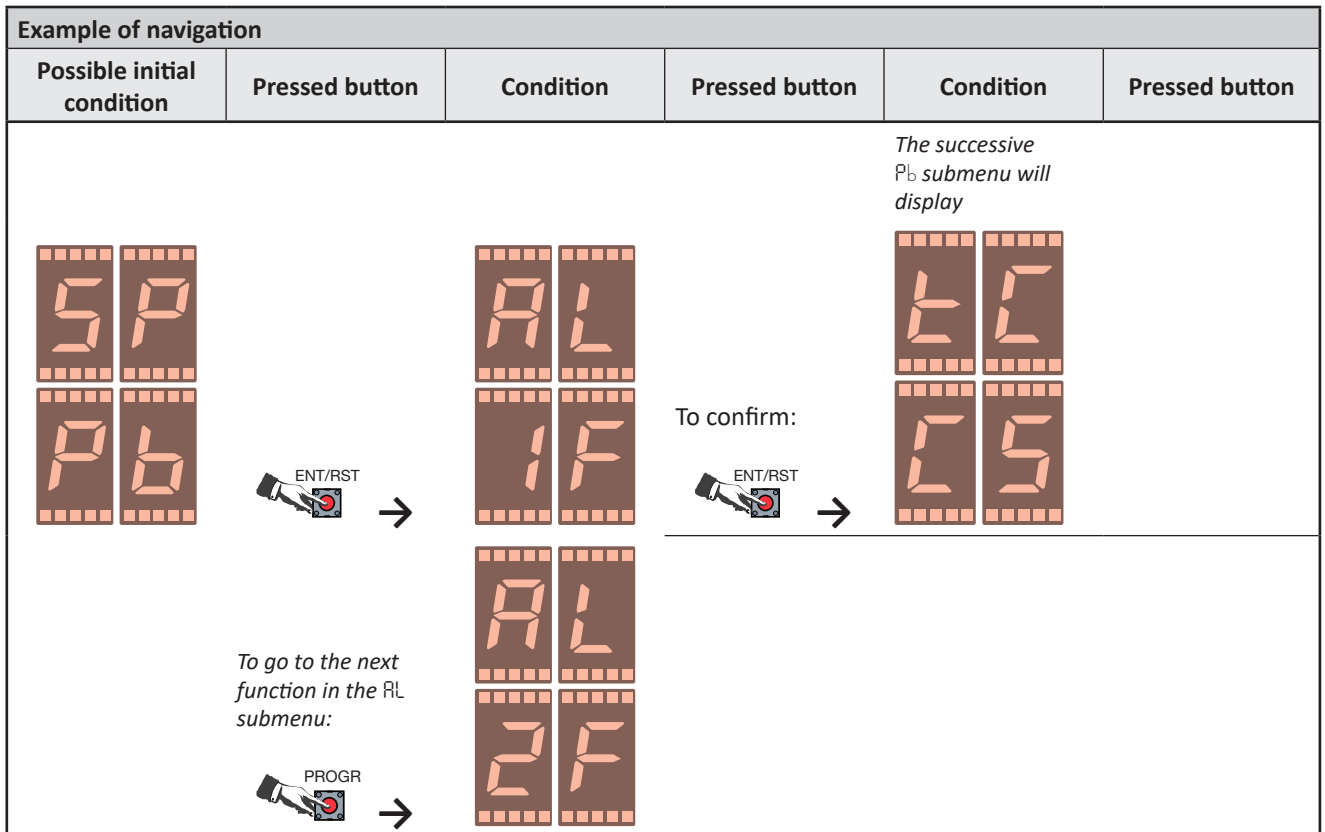

The display will show the code of the selected menu and the submenu code (if any) in alternation.

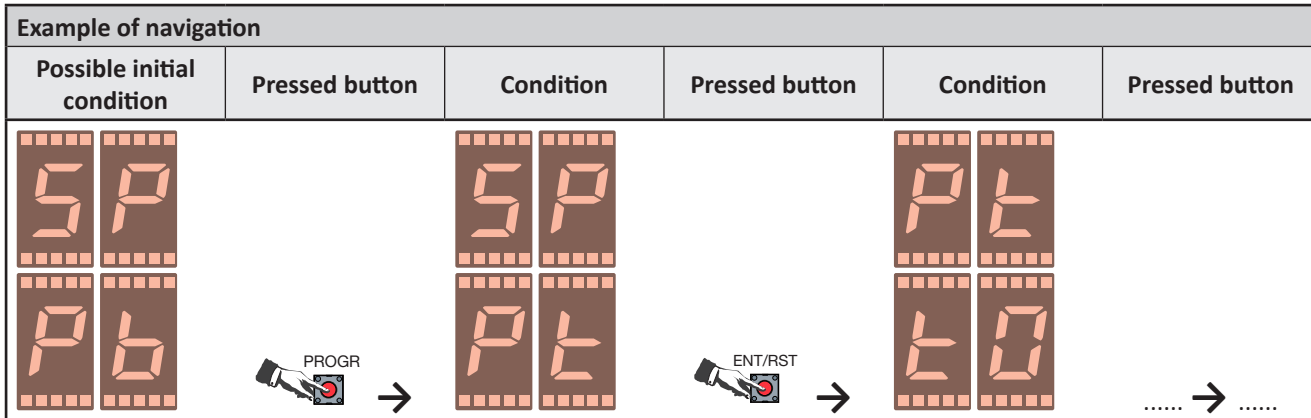



**IMPORTANT**

The following tables illustrate the complete programming structure, but some options may no longer display after certain functions have been set.



 			Basic programming
Codes	Values	Meaning	Description
AL	1F	rope 1 speed	<b>type of actuation</b>
	2F	rope 2 speed	
	1d	hydraulic	
	E <sub>n</sub> = no	standard shaft control, with reed switch + magnetic tracks	
	E <sub>n</sub> = YES	special shaft control, with shaft encoder	
	CF	variable frequency drive	
	E <sub>n</sub> = no	standard shaft control, with reed switch + magnetic tracks	
	E <sub>n</sub> = YES	special shaft control, with shaft encoder	
E <sub>r</sub>	no	not active	<b>CRS/CRD NOT MANAGED BY BOARD</b>
	yes	active	<b>CRS/CRD MANAGED BY BOARD</b>
L <sub>b</sub>	no	not active	if active: enables control by the microprocessor board of the bistable inspection ramp down switch on the lowest floor. RIDB.
	yes	active	
L <sub>H</sub>	no	not active	if active: enables control by the microprocessor board of the bistable inspection ramp down switch on the uppermost floor. RISB.
	yes	active	
TC	CS	universal	<b>Type of manoeuvre</b>
	CD	collective down	
	CP	car: universal Floors: reserve in order of call	
	Sc	floors: universal Car: reserved	
	CC	car: reserve. Floors: collective complete	



CL	S	simplex	<b>type of installation</b>	
	SS	simplex with selective access		
	d	duplo/duplex/triplex/ quadruplex		
	dS	duplo/duplex/triplex/ quadruplex with selective access		
Rd	Rd = 00	car A	<b>duplo/duplex/triplex/quadruplex: car setting</b>	
	Rd = 01	car B		
	Rd = 02	car C		
	Rd = 03	car D		
In	no	not active	<b>call inhibited with universal manoeuvre (two systems with universal manoeuvre). While one car arrives at the floor, the other cannot be called to the same floor, unless the first has not already stopped.</b>	
	YES	activates		
J3	nU	not utilised	<b>use of FLSER input J3</b>	
	RC	enable floor calls		
	EP	inhibit floor calls		
	oS	hospital call		
	CU	priority up call		
	bP	access control bypass		
J4	nU	not utilised	<b>use of FLSER input J4</b>	
	RC	enable floor calls		
	EC	inhibit floor calls		
	FI	fireman call		
	Ed	priority down call		
	rI	return to main floor		
UP	1 to 31		<b>last floor setting</b>	
PP	0 to UP		<b>main floor setting</b>	
RC	0 to UP		<b>accesses/opening side setting</b>	
	R.C.	0.0		front, floor 0
	R.C.	00.		rear, floor 0
	R.C.	0.0.		front+rear, floor 0
P.F	0 to UP		<b>fire services floor setting</b>	
tF	00	standard: fire services manoeuvre EN81 (EU regulatory)	<b>fire services manoeuvre selection</b>	
	01	fire services manoeuvre ASME (USA regulatory)		
	02	fire services manoeuvre EN81- 72		
	03	fire services manoeuvre EN81- 73		
	04-07	not utilised		





rF	no	any floor	fire services manoeuvre exit mode when J12/1 drops (led FRM)
	YES	to fire services floor	
PE	0 to UP		evacuation floor setting
tE	00	standard: evacuation manoeuvre EN81 (EU regulatory)	evacuation manoeuvre selection
	01	evacuation manoeuvre ASME (USA regulatory)	
	02	evacuation manoeuvre EN81-72/EN81-73	
	03-07	not utilised	
rE	no	any floor	evacuation manoeuvre exit mode when J12/1 drops (led FRM)
	YES	at evacuation floor	
FS	0 to UP		only if Elettroquadri has set "parking out of service floor (CFS)"
PR	PP to UP	-- = PP	duplo/duplex/triplex/quadruplex: alternative parking floor
PS	0 to UP		duplo/duplex/triplex/quadruplex: floors not served (skip floors).
	P.S	front	
	PS.	rear	
	P.S.	front+rear	
PU	0 to UP		special floors and accesses (duplex only) (the button of the select floor calls its own car)
Pc	no	park with doors open	doors parked at floor
	YES	park with doors closed	
CP	0 to UP		setting parking with doors closed/open on different floors
	C.P	front doors closed	
	CP.	rear doors closed	
	C.P.	front+rear doors closed	
IP	no	park at last served floor	send car to parking
	YES	sends to parking	
PR	no	opens	block doors opening for testing
	YES	does not open	

 				Timer programming	
Code	range	unit of measurement	default	meaning and use	
t0	20 to 90	sec	20.	high speed travel time in normal operation	
t1	2 to 60	sec	04.	floor time (time for which the doors remain open)	
t2	0 to 30	dsec	0.0	door open delay after retiring cam drops	
t3	1 to 90	sec	05. (x10)	simplex: return to main floor time	
t4	1 to 90	min	15	hydraulic: return to lowest floor time	



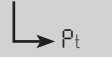





 				Timer programming
Code	range	unit of measurement	default	meaning and use
t5	8 to 60	sec	15.	maximum doors open/close movement time
t6	0 to 30	dsec	0.0	open command hold time after open limit switch tripped
t7	0 to 30	dsec	1.5	close command hold time after close limit switch tripped
t8	20 to 90	dsec	4.0	occupied hold time after doors closed
t9	0 to 99	dsec	0.0	hydraulic: star/delta switching delay
tA	0 to 99	dsec	0.0	hydraulic: motor stop delay at floor
tb	4 to 250	dsec	0.4	DRA/DRB signal wait delay
tC	20 to 250	sec	2.0	duplo/duplex/triplex/quadruplex: emergency car start time
td	5 to 99	sec	15.	duplo/duplex/triplex/quadruplex: start wait time for parking
tE	50 to 250	sec	00.	duplo/duplex/triplex/quadruplex: closest call function activation time
tF	0 to 250	sec	0.0	only if Elettroquadri has set "PICK-UP manoeuvre": main floor departure delay
tH	0 to 50	dsec	0.0	contactor excitation delay after slide excitation
tL	0 to 99	sec	70	duplo/duplex/triplex/quadruplex: car out of service time
tn	3 to 30	sec	20.	travel time at low speed
to	0 to 25	dm/sec	0.0	reset mode setting: if = 0.0 resetting with stop on phase plug and restart if = car speed (m/s) resetting without interrupted travel
tp	10 to 99	dsec	2.5	J11/1 signal drop wait time (FSC)
tr	0 to 10	dsec	0.0	up travel stop delay after DM magnetic track engaged
tt	0 to 10	dsec	0.0	down travel stop delay after UM magnetic track engaged
tU	0 to 99	num	20	duplo/duplex/triplex/quadruplex: K = forgotten call coefficient K not = 0 (minimum 20 sec. delay) K= sec. wait X floors (not ground) divided by number of cars
P0	2 to 50	dsec	0.3	variable speed drive: contactor closure delay: up/down/low speed when J11/1 signal not present (FSC)
P1	0 to 120	sec	00	variable speed drive: board initialisation delay on power on
P2	0 to 50	dsec	0.0	call execution delay after swing door closure
P3	3 to 250	sec	25.	timed car light off delay
P4	0 to 99	dsec	0.0	retiring cam drop delay at stop
P5	5 to 60	dsec	3.0	J11/1 signal wait time (FSC)
P6	0 to 80	dsec	2.0	resetting delay without travel interruption (parameter T0 = resetting mode selection)
P7	0 to 250	sec	00.	A3 hydraulic: valve excitation time during lowest floor test if = 0 the test does not run

 ENT/RST  Pt				Timer programming	
Code	range	unit of measurement	default	meaning and use	
P8	0 to 80	dsec	0.0	<b>A3 hydraulic:</b>	
				2U = YES bt = 00	excitation advance time for 2nd valve on start
				2U = no bt = 01	J12/3 present/absent (CF5, led CF5) for Moris EKMI valve control
				2U = no bt = 02	2 J12/2 (CF4, led CF4) and J12/3 (CF5, led CF5) inputs present/absent together timer for GMV/NGV-A3 valve control
P9	0 to 80	dsec	0.0	<b>A3 hydraulic:</b>	
				2U = YES bt = 00	de-excitation delay timer for 2nd valve on stop
				2U = no bt = 02	2 motor de-excitation delay timer when RUN signal drops (GMV/NGV-A3)
PA	0 to 50	dsec	0.0	hydraulic: up releveling stop delay after DM reed	
Pb	0 to 50	dsec	0.5	hydraulic: down releveling stop delay after UM reed	
PC	0 to 50	dsec	0.0	hydraulic: departure delay after releveling following call	
Pd	0 to 50	dsec	1.0	gong pulse duration	
PE	0 to 15	min	10	photocell occlusion alarm delay (0 = disabled)	
PF	0 to 99	min	20	time after which lockout due to excessive attempts to open/close the door is reset (0 = disabled)	
PH	0 to 50	dsec	0.0	startup present delay (FLSER)	
PL	20 to 90	sec	20.	high speed travel time during reset	
Pn	5 to 120	min	10	energy saving activation time (ES=YES)	
Po	10 to 90	sec	2.0	variable speed drive: call disable time after energy saving activation (equal to inverter shutdown time)	
PP	0 to 60	sec	00	STAFF manoeuvre: door open hold time at selected floor (SF = enabled)	
Pr	0 to 90	sec	00	using the WeLift app: call drop wait time	
U01	0 to 20	sec. (with dot on) min. (with dot off)		Normal manoeuvre actuation delay timer	
U02	0 to 20	sec. (with dot on) min. (with dot off)		Emergency manoeuvre actuation by board delay timer	
U03	0 to 20	sec. (with dot on) min. (with dot off)		Emergency manoeuvre by board maximum duration timer	























 			Option programming
Codes	Values	Meaning	Description
FC	no	does not monitor	phase control
	YES	monitors	
Rc	R.c	front	self-retaining in door closure
	R.c.	rear	
	R.c.	front+rear	
Ro	R.o	front	self-retaining in door opening
	R.o.	rear	
	R.o.	front+rear	
do	1 to 4		number of logical floor backbones
bU	1 to 7	default level 07	volume of car/floor reserved confirmation beep. Level 0 selects the electronic buzzer (no resonator)
SC	no	disabled	collective down manoeuvre: double selection main floor call button
	YES	active	
Rr	no	disabled (restart when button released)	restart after car stopped with "Alt" button
	YES	active (restart with car call)	
rE	no	disabled	rope: restart after ER-23 (travel limit or fall arrester)
	YES	active	
rL	r.L	excessive time taken to leave the floor	conditions enabling restart after travel timeout (max 2 consecutive attempts)
	r.L.	low speed travel timeout (max 2 consecutive attempts)	
	r.L.	"leave floor" or "low speed" or "high speed" travel timeout	
PH	no	disabled	enable door open/close control with car roof maintenance panel (the wiring diagram must be changed – contact Elettroquadri - )
	YES	active	
Cc	no	disabled	hydraulic: second safety circuit check before out of service
	YES	active	
rP	no	disabled	hydraulic: second releveling attempt
	YES	active	
2u	no	disabled	A3 hydraulic: enable operation of 2nd down travel valve
	YES	active	
Cb	no	disabled: car call button actuation, closes the doors and resets floor time	floor time timeout (door closure)
	YES	enabled: doors close on car call disabled (to close: DCB or wait for floor time to time out)	
nF	no	disabled (the car parks at the set floors)	duplo/duplex/triplex/quadruplex operation: force parking at main floor
	YES	enabled (car returns to main floor)	





 			Option programming
Codes	Values	Meaning	Description
bt	00	disabled	<b>A3 hydraulic: assignments of inputs J12/2 (CF4, led CF4) and J12/3 (CF5, led CF5)</b>
	01	enabled: Moris EKMI valve control	
	02	enabled: GMV/NGV-A3 valve control	
	03-15	not used	
Pr	no	disabled	<b>selective access: enable reduced interfloor manoeuvre RA/RB</b>
	YES	active	
uL	no	disabled	<b>enable releveling, monitor inputs J12/2 (CF4, led CF4) and J12/3 (CF5, led CF5)</b>
	YES	active	
CS	no	disabled	<b>hydraulic: safety circuit control</b>
	YES	active	
dR	no	disabled	<b>pre-open doors (active in ramp down)</b>
	YES	active	
Sd	no	disabled	<b>inspection manoeuvre using car buttons connected to inputs 0C/1C of M1A/M1B terminal block</b>
	YES	active	
br	no	disabled	<b>block second attempt to open with floor button</b>
	YES	active	
Go	Go	in slowdown	<b>gong operation</b>
	Go.	on stop	
	Go.o.	on doors opening	
LU	LU	standard	<b>car light operation</b>
	LU	with KM0+: scheduled	
	LU.	always on	
CF	no	in slowdown	<b>collective down or complete manoeuvre: cancel floor call reservation</b>
	YES	on stop	
rl	no	disabled	<b>conditional return enable</b>
	YES	enabled	
En	no	not motorized	<b>motorized floor doors</b>
	YES	motorized	
bC	no	disabled	<b>brake control with FLFRN board</b>
	YES	active	
CR	no	disabled	<b>enable operation with code (keypad or RFID)</b>
	YES	active	
ES	no	disabled	<b>enable energy saving function</b>
	YES	active	



 			Option programming
Codes	Values	Meaning	Description
GR	GR	standard	<b>Rope: intermediate speed operation (AUX)</b>
	GR	with start in GV ignores the next floor	
	GR.	with AUX set does not change destination	
Jo	no	disabled	<b>monitor repeated releveling (yo-yoing)</b>
	YES	active	
EP	no	disabled	<b>with EN81-20/EN81-50 standard: car door aux contact control</b>
	YES	active	
Pn	00	disabled	<b>chain jumper control protocol</b>
	01	up to release 51-36 (no longer in use)	
	02	active	
	03-15	not used	
nU	no	disabled	<b>for underground floors: forced parking at main floor</b>
	YES	active	
Lt	no	disabled	<b>lockout due to too many door close attempts</b>
	YES	active	
ER	no	disabled	<b>If active:</b> <ul style="list-style-type: none"> <li>• with one access: emergency stop with UM+DM (without supplementary reed switches)</li> <li>• with two accesses: emergency stop with UM+DM, door selectino with SEB (DRA) (UM+DM = open side A; UM+DM+SEB = open side B)</li> </ul>
	YES	active	

 ENT/RST  PL			Display and lights programming	
Codes	Values	Meaning	Description	
dP	FP	1 row per floor	<b>type of floor display</b>	
	Gr	gray		
	 oF	0 to 7		floor display offset
	 Ab	no		absolute gray code, floor display
		YES		
	bn	binary		
	 oF	0 to 7		floor display offset
	 Ab	no		absolute binary code, floor display
		YES		
	7S	7 segments		
 oF	0 to 7	floor display offset		
LC	serial display			
 oF	0 to 7	floor display offset		
dC	FP	1 row per floor	<b>type of car display (serial only)</b>	
	Gr	gray		
	 oF	0 to 7		car display offset
	 Ab	no		absolute gray code, car display
		YES		
	bn	binary		
	 oF	0 to 7		floor display offset
	 Ab	no		absolute binary code, car display
		YES		
	7S	7 segments		
 oF	0 to 7	floor display offset		
LC	serial display			
 oF	0 to 7	floor display offset		
Fc	 F.c	direction arrows active	<b>car display direction arrows</b>	
	 F.c	direction arrows not active		
Fd	 F.d	direction arrows	<b>floor display direction arrows</b>	
	 F.d	next direction arrows		



 			Display and lights programming
Codes	Values	Meaning	Description
F1	no	never together	<b>next direction arrows on even when direction is not defined (together)</b>
	YES	together when no direction	
J3	OC	occupied	<b>J3 light operation</b>
	OL	occupied flashing	
	P <sub>r</sub>	present (default)	
	IA	arriving at floor	
	IC	arriving at car	
	FS	out of service	
	nu		
J4	OC	occupied	<b>J4 light operation</b>
	OL	occupied flashing	
	P <sub>r</sub>	present	
	IA	arriving at floor	
	IC	arriving at car	
	FS	out of service (default)	
	nu		
J5	OC	occupied	<b>with universal manoeuvre: J5 light operation</b>
	OL	occupied flashing	
	P <sub>r</sub>	present	
	IA	arriving at floor (default)	
	IC	arriving at car	
	FS	out of service	
	nu		
J6	OC	occupied (default)	<b>with universal manoeuvre: J6 light operation</b>
	OL	occupied flashing	
	P <sub>r</sub>	present	
	IA	arriving at floor	
	IC	arriving at car	
	FS	out of service	
	nu		



Indication on the display	Description
	Programming end

**IMPORTANT**

*In case of error (programming is interrupted) everything programmed up to that time is saved.*

## 4.4. FURTHER REMP2 PROGRAMMER FUNCTIONS

The following other functions are available in the SP Main Menu:

### 4.4.1. LE SELECTION - FAULT LOG READING

Hold down **PROGR** until LE displays, then press **ENT/RST**. The display reads:

1. If no errors are memorized, the display indicates  $\square E$ ;
2. the display shows the first saved error with the indication "ER+number" (see chapter 5 Diagnostics);
  - Hold down **PROGR** to display the floor at which the error or fault occurred, as "PE+floor number"
  - If, instead of the floor number, "RF" displays, the system was resetting; if "HH" displays, the system was in inspection mode
  - Press **ENT/RST** to scroll to the next entry.
  - At the end of the scan, the display reads "FE".
3. press **ENT/RST** to start the sequence again;
4. otherwise press **PROGR** to display a flashing  $\square E$  (cancel);
5. press **ENT/RST** to cancel;
6. you can quit the procedure at any time by simply closing the automatic valve.

### 4.4.2. FO SELECTION - OMNIBUS PROCEDURE

To initiate the manoeuvre, press **ENT/RST** once, close the automatic valve **VA** or safety chain switch **IM** (optional):

1. the car starts moving up and down;
2. if any calls are made, they are handled in the normal manner;
3. once the limit of 50 is reached, the process terminates;
4. to deactivate it at any time, hold **ENT/RST** down for at least 10 sec.

### 4.4.3. EC SELECTION - TRAVEL LIMIT TEST

**IMPORTANT**

*See the test manual.*

### 4.4.4. IN SELECTION - UNCONTROLLED MOVEMENT TEST

**IMPORTANT**

*See the test manual.*





---

PAGE LEFT INTENTIONALLY BLANK

---

# 5 DIAGNOSTICS

## 5.1. GENERAL WARNINGS

It is assumed, for the safe use of the board, that the reader of this chapter is already familiar with the contents of heading 2.2 "Safety Warnings".



INSTALLER

## 5.2. FAULT TABLE AND FAULT FINDING

The faults are shown on the REMP2 display **alternating** the error message "ER" with the **number of the identified fault**. These can be:

- (R) Recoverable faults: **the lift is still operative and restarts with next call**.
- (NR) **Non recoverable faults**: the lift goes out of order and the MP3 board must be reset; the error is deleted in case of power failure, (faults Er - 25/25/27 are kept in memory).

### Error code      Fault origin and actions to be taken

<u>Error code</u>	<u>Fault origin and actions to be taken</u>
Er-01	(R) <b>Phase reversal or phase loss</b>
<p>The board makes this control receiving at terminals J2/2(PHA) and J2/3(PHB) the signals PHA, PHB coming from ACF power supply board.</p> <p>Verify:</p> <p>For phase reversal:</p> <ul style="list-style-type: none"> <li>• Swap two of phases R/S/T on the terminal block (then check the rotation of the hoisting motor and door operator motor).</li> </ul> <p>For phase loss:</p> <ul style="list-style-type: none"> <li>• verify R/S/T phases on main input terminals.</li> <li>• verify R/S/T phases on ACF board terminals.</li> <li>• Fuses F1/F2/F3.</li> <li>• Present, on the board at inputs J2/2 (PHA) and J2/3 (PHB), approx. 13 VDC relative to GND.</li> </ul> <p>Note: if it is needed to eliminate the phase control, see heading 4.5 "Other functions on the REMP2 remote terminal".</p>	

<u>Error code</u>	<u>Fault origin and actions to be taken</u>
Er-02	(R) <b>Thermal protection (TP) tripped</b>
<p>It is signalled when on board terminal M2A/1, a resistance value greater than 2000 ohm as to GND is detected.</p> <p>Hydraulic: the car goes to the lowest floor.</p> <p>Rope: the car stops at the nearest floor.</p> <p>4 min. after temperature reset, the lift returns into service. Showing on the display a countdown (every 3 seconds) from 80 to 0.</p> <p>Verify:</p> <ul style="list-style-type: none"> <li>• Connection to GND and thermistor resistance value and any other contact wired in series on the same circuit.</li> <li>• Direct wiring to GND (without thermistors).</li> <li>• Controller ground connection of main line.</li> <li>• Brake contact malfunction.</li> </ul>	



Er-03	(R)	<b>No closure of high speed (GV) / low speed (PV) / (power (P) for 1 speed system) / retiring cam (RP)</b>
<p><i>At start up the board does not measure 24 VDC on input J11/1 (FSC) to confirm excitation of the high speed (GV) / low speed (PV) contactors.</i></p>		
<p><i>Verify:</i></p> <ul style="list-style-type: none"> <li>• Excitation of the high speed (GV) / low speed (PV) / power (P with 1 speed) contactors</li> <li>• Excitation, if installed, of the RP contactor and retiring cam.</li> <li>• Voltage at the end of safety chain, after the landing door lock contacts (when activated by the retiring cam).</li> <li>• Input voltage at board terminals J8/8 (PV, led PV), J8/5 (GV, led GV).</li> <li>• Input voltage with controls activated at board terminals J8/7 (PV, led PV), J8/6 (GV, led GV).</li> <li>• With the high speed (GV) / low speed (PV) contactors excited, their auxiliary contacts wired between the +24 terminal and the board's J11/1 (FSC, led IA) connector input.</li> </ul>		
Er-04	(R)	<b>No closure of the up (S) / down (D) contactors</b>
<p><i>At start up the board does not measure 24 VDC on input J11/2 (UD, led IB) to confirm excitation of the up (S) / down (D) contactors.</i></p>		
<p><i>Verify:</i></p> <ul style="list-style-type: none"> <li>• Excitation of the up (S) / down (D) contactors.</li> <li>• Voltage at terminals CRS/CRD or CRSB/CRDB (top and bottom floor phase plug contactors).</li> <li>• Input voltage at board terminals J8/1 (S, led S), J8/4 (D, led D).</li> <li>• Input voltage with controls activated at board terminals J8/2 (S, led S), J8/3 (D, led D).</li> <li>• NC contact of the electrical reciprocal of the up (S)/down (D) contactors.</li> <li>• With the up (S) or down (D) contactor excited, the corresponding auxiliary contacts connected between +24 and board input J11/2 (UD, led IB).</li> <li>• With amendment A3: <ul style="list-style-type: none"> <li>▪ Gearless: no main brake de-excitation control contact closure; Geared: no auxiliary brake de-excitation control contact closure.</li> <li>▪ No excitation of the brake contact control contactors, or their contacts are defective.</li> <li>▪ No closure of the de-excitation control contact of the speed governor coil (Montanari or similar).</li> </ul> </li> </ul>		
Er-05	(R)	<b>No closure of the power contactors (TL1 / TL2)</b>
<p><i>At start up the board does not measure 24 VDC on input J11/5 (CCS, led CCS) to confirm excitation of the power contactors (TL1 / TL2).</i></p>		
<p><i>Verify:</i></p> <ul style="list-style-type: none"> <li>• Excitation of the power contactors (TL1 / TL2)</li> <li>• Voltage at the up (S) / down (D) contactor contacts which control the power contactors (TL1 / TL2).</li> <li>• Variable speed drive fault signal contact (see error on the variable speed drive keypad).</li> <li>• With the power (TL1 / TL2) contactors excited, the corresponding auxiliary contacts connected between +24 and board input J11/5 (CCS, led CCS).</li> </ul>		
Er-06	(R)	<b>No door closure</b>
<p><b>Case 1:</b> <i>once door closure has timed out (t5 = 15 seconds), the board does not receive the door contacts closed signal at terminal J7/10 (D4). Led D4 does not light up.</i></p>		
<p><i>Verify:</i></p> <ul style="list-style-type: none"> <li>• Car door or door lock contacts (if no retiring cam is present).</li> <li>• Minirelay or door closure contactor does not excite.</li> <li>• Door closure limit switch is open.</li> <li>• NC contact of the electrical reciprocal of the door open contactor.</li> <li>• No control signal output from the board at terminal J6/10 (CPO, led CP).</li> <li>• No power to the car door motor (if three-phase).</li> <li>• No power to the car door regulator board (single-phase 220 VAC).</li> <li>• No closure signal to the car door regulator board (single-phase 220 VAC).</li> <li>• Delay t5 timeout (15 seconds).</li> </ul>		
<p><b>Case 2:</b> <i>after the door closure delay has timed out (t5 = 15 seconds), input J11/3 (DRA, led IC) or J11/4 (DRB, led ID) still carries the 24 VDC voltage from the door closure contactor.</i></p>		
<p><i>Verify:</i></p> <ul style="list-style-type: none"> <li>• No opening of the door closure limit switch.</li> <li>• With the operator power and running disconnect the door closure contact from input J11/3 (DRA, led IC) or, if double access, contact J11/4 (DRB, led ID).</li> </ul>		



ER-07	(R)	<b>No door opening</b>
<p><b>Case 1:</b> once door opening has timed out (<math>t_5 = 15</math> seconds), the board does not see termination of the door contacts open signal at terminal J7/10 (D4, led D4). Led D4 remains on.</p>		
<p>Verify:</p> <ul style="list-style-type: none"> <li>• Door opening contactor does not excite.</li> <li>• Door opening limit switch is open.</li> <li>• NC contact of the electrical reciprocal of the door closure contactor.</li> <li>• No control signal output from board terminal J6/8 (led APB) and J6/9 (led APA).</li> <li>• No power to the car door motor (if three-phase).</li> <li>• No power to the car door regulator board (single-phase 220 VAC).</li> <li>• No open signal to the car door regulator board (single-phase 220 VAC).</li> </ul>		
<p><b>Case 2:</b> once door opening has timed out (<math>t_5 = 15</math> seconds), connector J11/3 (DRA, led IC) or J11/4 (DRB, led ID) input still has the 24 VDC voltage carried by the door opening contactor.</p>		
<p>Verify:</p> <ul style="list-style-type: none"> <li>• No opening of the open limit switch.</li> <li>• Delay <math>t_5</math> timeout (15 seconds).</li> </ul>		
ER-08	(R)	<b>UM count error</b>
<p>An extra pulse is counted in the up count sequence.</p>		
<p>Verify:</p> <ul style="list-style-type: none"> <li>• Presence of all magnetic strips.</li> <li>• Correct positioning of the magnetic strips relative to the UM reed switch.</li> <li>• Minimum distance between consecutive strips to enable pulse counting.</li> <li>• Failure of the flexible cable.</li> </ul>		
ER-09	(R)	<b>DM count error</b>
<p>An extra pulse is counted in the down count sequence.</p>		
<p>Verify:</p> <ul style="list-style-type: none"> <li>• Presence of all magnetic strips.</li> <li>• Correct positioning of the magnetic strips relative to the DM reed switch.</li> <li>• Minimum distance between consecutive strips to enable pulse counting.</li> <li>• Failure of the flexible cable.</li> </ul>		
ER-10	(R)	<b>D1 safety chain control</b>
<p>When the car is moving, no signal to the board at input J7/4 (D1, led D1).</p>		
<p>Verify:</p> <ul style="list-style-type: none"> <li>• All contacts in the safety chain upline of input J7/4 (D1, led D1) - see the wiring diagram.</li> </ul>		
ER-11	(R)	<b>D3 safety chain control</b>
<p>When the car is moving, no signal to the board at input J7/8 (D3, led D3).</p>		
<p>Verify:</p> <ul style="list-style-type: none"> <li>• All contacts in the safety chain between input J7/4 (D1, led D1) and J7/8 (D3, led D3) - see the wiring diagram.</li> </ul>		
ER-12	(R)	<b>D4 safety chain control (lacking)</b>
<p>When the car is moving, no signal to the board at input J7/10 (D4, led D4).</p>		
<p>Verify:</p> <ul style="list-style-type: none"> <li>• All contacts in the safety chain between input J7/8 (D3, led D3) and J7/10 (D4, led D4) - see the wiring diagram.</li> </ul>		
ER-13	(R)	<b>Stopped away from floor</b>
<p>When the car arrives at the floor inputs UM (M2A/2) and DM (M2A/3) are missing on the board. Rope, 1 or 2 speeds: the car resets.</p>		



Verify:		
<ul style="list-style-type: none"> <li>• Brake regulation.</li> <li>• Magnetic strip position.</li> <li>• Slowdown distance.</li> </ul>		

ER-14	(R)	<b>D4 safety chain control (present)</b>
<i>With the car moving, no signal to board inputs J11/1 (FSC, led IA) and J11/2 (UD, led IB) simultaneously.</i>		
Verify:		
<ul style="list-style-type: none"> <li>• All contacts in the safety chain downline of input J7/10 (D4, led D4) - see the wiring diagram.</li> </ul>		

ER-15	(R)	<b>Safety circuit control for uncontrolled movement</b>
<i>On arrival at the floor with doors open and UM / DM reed switches present, no signal to board inputs RLD = J12/2 (CF4, led CF4) and RLS = J12/3 (CF5, led CF5).</i>		
Verify:		
<ul style="list-style-type: none"> <li>• Operation of RLS / RLD reed switches.</li> <li>• Magnetic strip position.</li> <li>• Operation of the safety circuit.</li> </ul>		

ER-16	(R)	<b>Door blocked due to photocell occlusion</b>
<i>Timeout (timer = PE) due to photocell occlusion.</i>		
Verify:		
<ul style="list-style-type: none"> <li>• Delay programmed in PE.</li> <li>• Photocell operation.</li> </ul>		

ER-17	(NR)	<b>No high speed (GV) / low speed (PV) contactor opening</b>
<i>Before starting, or for more than 20 seconds on arrival at the floor, the board reads 24 VDC at input J11/1 (FSC, led IA): the high speed (GV) / low speed (PV) contactors are still attracted.</i>		
Verify:		
<ul style="list-style-type: none"> <li>• Mechanical blockage of the high speed (GV) / low speed (PV) contactors.</li> <li>• Outputs J8/6 (GV, led GV) and J8/7 (PV, led PV) always active on the board.</li> </ul>		

ER-18	(NR)	<b>No opening of the up (S) / down (D) contactors</b>
<i>Before starting, or for more than 20 seconds on arrival at the floor, the board reads 24 VDC at input J11/2 (UD, led IB): the up (S) / down (D) contactors are still attracted.</i>		
Verify:		
<ul style="list-style-type: none"> <li>• Mechanical blockage of the up (S) / down (D) contactors.</li> <li>• Outputs J8/2 (S, led S) and J8/3 (D, led D) always active on the board.</li> <li>• Hydraulic: the releveling circuit, if independent of the board.</li> </ul>		

ER-19	(NR)	<b>Contactors TL1/TL2 do not open</b>
<i>Before starting, or for more than 20 seconds on arrival at the floor, the board reads 24 VDC at input J11/5 (CCS, led CCS): the power (TL1/TL2) contactors are still attracted.</i>		
Verify:		
<ul style="list-style-type: none"> <li>• Mechanical blockage of the power contactor (TL1 / TL2).</li> <li>• Outputs J8/2 (S, led S) and J8/3 (D, led D) always active on the board.</li> </ul>		

ER-20	(NR)	<b>Excessive time at high speed</b>
<i>Via reed switches UM / DM, the board detects high speed travel between consecutive floors of more than 45 seconds (time adjustable up to 60 seconds in parameter t0).</i>		
<i>Hydraulic: the car goes to the lowest floor.</i>		
<i>Rope: the car remains where it is.</i>		

**Verify:**

- During commissioning, check that the distance (m) between consecutive floors is greater than that obtained by multiplying the car speed (m/s) by 45 seconds; if the result is greater, a dummy floor must be created.
  - Operation of the UM / DM reed switches.
  - Magnetic strip position.
- 
- What can move the car at low speed or stop it between floors with the contactors excited (the 24 VDC at inputs J11/1 (FSC, led IA) and J11/2 (UD, led IB) remains):
    - Lack of a phase to the hoist motor or hydraulic power pack.
    - Rope: hoist brake not excited (but leaving the floor is still permitted).
    - Hydraulic: high speed solenoid valve not powered.
    - Variable speed drive: variable speed drive in error and car stopped between floors
    - Variable speed drive: no high speed signal to the variable speed drive.

ER-21

**(NR)****Excessive time at low speed**

*Via the UM / DM reed switches, the board detects a low speed travel time between the start of slowdown and the destination floor in excess of 20 seconds.*

*Hydraulic: the car goes to the lowest floor.*

*Rope: the car remains where it is.*

**Verify:**

- Operation of the UM / DM reed switches.
- Magnetic strip position.
- What can impede or delay arrival of the car at the floor, in the low speed travel space (PV), with contactors excited (24 VDC to board inputs J11/1 (FSC, led IA) and J11/2 (UD, led IB) is not lacking):
  - Rope: lack of a phase to the hoist motor.
  - Rope, 2 speeds: hoist brake not excited at low speed.
  - Variable speed drive: variable speed drive in error and car stopped between floors.
  - Variable speed drive: no low speed signal to the variable speed drive.
  - Variable speed drive: insufficient motor torque.

ER-22

**(NR)****Excessive time taken to leave the floor**

*Via the UM / DM reed switches, the board detects failure to leave the floor within a time of 10 seconds.*

*Hydraulic: the car goes to the lowest floor.*

*Rope: the car remains where it is.*

**Verify:**

- Operation of the UM / DM reed switches.
- What can impede or delay the car leaving the floor within 10 seconds of excitation of the contactors (the 24 VDC to board inputs J11/1 (FSC, led IA) and J11/2 (UD, led IB) is not lacking):
  - Lack of a phase to the hoist motor or hydraulic power pack.
  - Rope: hoist brake not excited.
  - Hydraulic: down solenoid valve not powered.
  - A3 hydraulic: 2nd down solenoid valve not powered.
  - Hydraulic: star/delta solenoid valve not powered.
  - Hydraulic: no switching of the star/delta contactors.
  - Hydraulic: no Soft Starter startup.
  - Variable speed drive: variable speed drive in error and car stopped between floors.
  - Variable speed drive: no speed signal to the variable speed drive.
- With amendment A3:
  - Gearless: no main brake de-excitation control contact closure; Geared: no auxiliary brake de-excitation control contact closure.
  - No closure of the excitation control contact of the speed governor coil (Montanari).

ER-23

**(NR)****Safety chain contacts between "D1" and "D2" tripped or fall arrestor contact tripped**

*Signal to input J7/6 (D2, led D2) lacking, but signal to input J7/4 (D1, led D1) present: the overtravel contact has opened.*

*Hydraulic: the car goes to the lowest floor.*

*Rope: the car remains where it is.*

*Travel limit checks:*

- Operation of the UM / DM reed switches.
- Operation and positioning of slowdown controls CRS/CRD or CRSB/CRDB.
- Distance between magnetic slowdown strip at the top and lowest floors and slowdown controls CRS/CRD or CRSB/CRDB.
- Distance of the overtravel contact from the top or lowest floors.
- The car must travel, under any loading conditions, a few cm at low speed before it receives the stop signal.
- Variable speed drive: brake regulation (opening and compression).

*Other contact checks:*

- Safety chain contacts between inputs J7/4 (D1, led D1) and J7/6 (D2, led D2): see control enclosure wiring diagram

**ER-24 (NR) Releveling failure**

*In hydraulic lift systems, the board controls releveling when J11/5 (CCS, led CCS) is receiving the "active" signal from the safety circuit and the UM or DM reed switch signal is lacking, to indicate that the car has moved up or down relative to the floor.*

*N.B. If in error, the car goes to the lowest floor.*

**Case 1:** *the car relevels when travelling upwards but does not close the DM reed switch within 15 seconds; the contactors remain excited and continue to relevel (releveling is stopped by the thermistors or after a timeout of 60 seconds which interrupt the operating circuit).*

*Verify:*

- Operation of the DM reed switch.
- Lack of power or single-phase power to the motor.
- Soft Starter failure.
- Overloaded car.
- Failure to excite of a motor power contactor.
- Oil delivery valve closed.

**Case 2:** *in the presence of the up or down releveling signal, the contactors do not excite within 15 seconds (releveling circuit malfunction).*

*Verify:*

- Safety circuit and GV contactor contacts in parallel with the car door and landing door lock contacts.
- CRS/CRD or CRSB/CRDB phase plugs.

**Case 3:** *relevels in downwards travel but the UM reed switch does not close within 15 seconds.*

*Verify:*

- Operation of the UM reed switch.
- No power to or mechanical blockage of the down valve.
- Failure to excite of a down valve power contactor.
- Oil delivery valve closed.

**ER-25 (NR) Safety circuit malfunction (it did not close at the floor)**

*In hydraulic systems, the board controls the status of the safety circuit via a 24 VDC signal at J11/5 (CCS, led CCS): the "active" safety circuit signal must be present when the car is at the floor (see the paragraph "Safety circuit" for details).*

*N.B. If in error, the car goes to the lowest floor and remains there out of service.*

*Verify:*

- With the car at the floor:
  - 24 VDC at input J11/5 (CCS, led CCS).
  - 24 VDC at terminals RZA/RZB (via the respective reed switches) and excitation of the corresponding minirelays.
  - Check the safety circuit.
- Defective board (if reporting an error with the signal present).

**ER-26 (NR) Reset failure (CRS/CRD open)**

*During reset, when the up or down signal is sent, the board does not have 24 VDC at J11/1 (FSC, led IA) after two/four attempts, or does not receive 24 VDC at J11/2 (UD, led IB).*

**Verify:**

- CRS/CRD or CRSB/CRDB phase plugs.
- The up/down board control signals at outputs J8/2(S, led S) and J8/3(D, led D).
- The reciprocal contacts in series with the up (S)/down(D) contactors.
- The up (S) / down (D) contactor coils.
- With amendment A3:
  - Gearless: no main brake de-excitation control contact closure; Geared: no auxiliary brake de-excitation control contact closure.
  - No excitation of the brake contact control contactors, or their contacts are defective.
  - No closure of the de-excitation control contact of the speed governor coil (Montanari).

**ER-27 (NR) Safety circuit malfunction (it did not open when the floor was left)**

*In hydraulic systems, the board controls the status of the safety circuit via a 24 VDC signal at J11/5 (CCS, led CCS): the "active" safety circuit signal must terminate when the car is away from the floor.  
The control is run when the car transits the slowdown strip at the destination floor: if in error, the car is moved to the lowest floor and remains out of service.*

**Verify:**

- If 24 VDC is present at input J11/5(CCS, led CCS) with the car away from the floor, verify:
  - Operation of the reed switches and minirelay RZA/RZB.
  - Check the safety circuit.

**ER-28 (NR) UM reed count error**

*The board monitors the operation of the UM (M2A/2) and DM (M2A/3) reed switches: 24 VDC present when the reed switch is closed.*

**Verify:**

- Operation of the UM reed switch.
- Presence and positioning of the magnetic strips.
- Condition of the flexible cables.
- Presence of 24 VDC at the common contact of the UM/DM reed switches.

**ER-29 (NR) DM reed count error**

*The board monitors the operation of the UM / DM reed switches (inputs M2A/2 and M2A/3) (24 VDC present when the reed switch is closed).*

**Verify:**

- Operation of the DM reed switch.
- Presence and positioning of the magnetic strips.
- Condition of the flexible cables.
- Presence of 24 VDC at the common contact of the UM/DM reed switches.

**ER-30 (NR) Rope: movement detected while testing clamp "FA" (clamp "B" does not hold)****Verify:**

- Check clamp "B"

**ER-30 (NR) Operation test of the separate opening of the 1st valve failed**

*During testing at the lowest floor with the doors closed, the system releveled when the 1st valve opened.*

**Verify:**

- Operation of the 2nd valve.

**ER-31 (NR) Rope: movement detected while testing prove clamp "FB" (clamp "A" does not hold)****Verify:**

- Check clamp "A"

**ER-31 (NR) Operation test of the separate opening of the 2nd valve failed**

*During testing at the lowest floor with the doors closed, the system releveled when the 2nd valve opened.*





Verify:

- Operation of the 1st valve.

ER-32	(NR)	<b>Error in the return to service sequence following out of service</b>
-------	------	---

*For system in public service, the car, when reset after out of service, is moved to the top floor, in automatic, and executes all calls travelling downwards and monitors door opening. If the sequence does not complete successfully, an error is reported.*

ER-40	(NR)	<b>Flash memory programming error</b>
-------	------	---------------------------------------

- Call ELETTRQUADRI S.r.l.

ER-41	(NR)	<b>Insufficient power voltage (+24 V)</b>
-------	------	---

*The board verifies the power voltage between inputs J2/1 (GND) and J2/4 (24 VDC).*

Verify:

- 18 VAC at the transformer output and at the input to the ACF board.
- 24 VDC at the ACF board output.
- Power voltage and fuses F1/F2/F3.

ER-42	(NR)	<b>Programming data entry error</b>
-------	------	-------------------------------------

- Call ELETTRQUADRI S.r.l.

ER-43	(NR)	<b>Serial communications to car error</b>
-------	------	---

- For details refer to the serial connection manual.

ER-44	(NR)	<b>Serial comms error to floor call boards</b>
-------	------	--

*The display shows the sequence "Er-44 PA xx" where xx is the board address.*

Verify:

- FLSER floor boards.

ER-45	(NR)	<b>MPCAB or CABSER board personalisation conflict</b>
-------	------	---

*The board checks the personalisation between the boards*

Verify:

- Personalisation between the boards.

ER-46	(NR)	<b>Incompatibility error between the various boards in floor serial transmissions</b>
-------	------	---

*Call ELETTRQUADRI S.r.l.*

ER-47	(NR)	<b>Call button blocked</b>
-------	------	----------------------------

*The board checks that a call button has been pressed.*

*The display shows the sequence "Er-47 Py xx" where xx is the button address and y is P for floors and C for the car.*

Verify:

- Check the operation of the call buttons (car/floor).
- Check the status of the call inputs on the FLSER boards.

ER-48	(NR)	<b>No Km0+ personalisation</b>
-------	------	--------------------------------

- Call ELETTRQUADRI S.r.l.

ER-65	(NR)	<b>Position and speed of car via the MP-ENC board</b>
-------	------	---

- Check the Mpen board

ER-66	(NR)	<b>Position and speed of car via the MP-ENC board = not active</b>
-------	------	--



- Check the Mpcnc board

ER-67	(R)	<b>When the front doors are opened, monitoring of the front door auxiliary contact opening</b>
<i>The board verifies the lack of input J21/3 (CF1, led CF1).</i>		
Verify:		
<ul style="list-style-type: none"> <li>• Operation of the front door auxiliary contact.</li> </ul>		
ER-68	(R)	<b>When the front car doors close, monitoring of the front door auxiliary contact closing</b>
<i>The board verifies the presence of input J21/3 (CF1, led CF1).</i>		
Verify:		
<ul style="list-style-type: none"> <li>• Operation of the front door auxiliary contact.</li> </ul>		
ER-69	(R)	<b>When the rear doors are opened, monitoring of the rear door auxiliary contact opening</b>
<i>The MPCAB board verifies the lack of input J21/4 (CF2).</i>		
Verify:		
<ul style="list-style-type: none"> <li>• Operation of the rear door auxiliary contact.</li> </ul>		
ER-70	(R)	<b>When the rear car doors close, monitoring of the rear door auxiliary contact closing</b>
<i>The MPCAB board verifies the presence of input J21/4 (CF2).</i>		
Verify:		
<ul style="list-style-type: none"> <li>• Operation of the rear door auxiliary contact.</li> </ul>		
ER-80	(NR)	<b>Releving error with UM/DM reed switch</b>
<i>With the car at the floor and the doors open, the signals of both reed switches UM (M2A/2) and DM (M2A/3) are lacking during releveling.</i>		
Verify:		
<ul style="list-style-type: none"> <li>• Operation of UM/DM reed switch (variable speed drive: RLS/RLD).</li> <li>• Magnetic strip position.</li> </ul>		
ER-81	(NR)	<b>Releveling error with safety circuit</b>
<i>With the car at the floor and the doors open, the car exits the doors zone during releveling.</i>		
Verify:		
<ul style="list-style-type: none"> <li>• Operation of UM/DM reed switch (variable speed drive: RLS/RLD).</li> <li>• Magnetic strip position.</li> </ul>		
ER-82	(NR)	<b>Malfunction of the Moris EKMI or GMV/NGV-A3 valve</b>
<i>During operation, the following faults are reported:</i>		
<ul style="list-style-type: none"> <li>• Moris EKMI valve = no 24 VDC at input J12/3(CF5, led CF5).</li> <li>• GMV/NGV-A3 valve = for longer than set in timer P8, inputs J12/2 (CF4, led CF4) and J12/3 (CF5, led CF5) are simultaneously either lacking or present.</li> </ul>		
Verify:		
<ul style="list-style-type: none"> <li>• Operation and information of the Moris EKMI board.</li> <li>• Operation and information of the GMV/NGV-A3 board.</li> </ul>		
ER-83	(NR)	<b>Excessive releveling error</b>
<i>With the car at the floor, it attempts to relevel every 60 s in both directions (yo-yo effect) at most 10 times.</i>		
Verify:		
<ul style="list-style-type: none"> <li>• Magnetic strip position.</li> <li>• Releveling frequency/speed.</li> <li>• Oil leak.</li> </ul>		
ER-84	(NR)	<b>Error: doors locked due to too many errors</b>



*The maximum number of door open or close cycles has been exceeded, displayed after error Er-06 or Er-07.*

Verify:

- See error Er-06.
- See error Er-07.

ER-86	(NR)	<b>Jumpers on car door contacts</b>
-------	------	-------------------------------------

*The board verifies the presence of input J7/8 (D3, led D3).*

Verify:

- Door contacts.

ER-87	(NR)	<b>Jumper on the landing door locks</b>
-------	------	---

*The board verifies the presence of input J7/10 (D4, led D4).*

Verify:

- Landing door lock contacts.

ER-88	(NR)	<b>The bypass relay does not excite</b>
-------	------	---

*No excitation of the jumper test relay/contactactor on the car doors and door locks.*

Verify:

- Operation of the RSVC minirelay.
- Operation of the PPCS contactor.

ER-89	(NR)	<b>Presence of car door auxiliary contact</b>
-------	------	---

*The board verifies the presence of input J21/6 (CF3, led CF3).*

ER-A0	(NR)	<b>Speed threshold error with MP-ENC board</b>
-------	------	--

*The set speed threshold has been exceeded.*

Verify:

- The set speed threshold.
- Slowdown spaces.

ER-A1	(NR)	<b>Generic brake error</b>
-------	------	----------------------------

ER-A2	(NR)	<b>CRS error with MP-ENC board</b>
-------	------	------------------------------------

*The MP-ENC board detects a speed in excess of the speed setting.*

Verify:

- The set speed threshold.
- Slowdown spaces.

ER-A3	(NR)	<b>CRD error with MP-ENC board</b>
-------	------	------------------------------------

*The MP-ENC board detects a speed in excess of the speed setting.*

Verify:

- The set speed threshold.
- Slowdown spaces.

ER-A4	(NR)	<b>CRS1 error with MP-ENC board</b>
-------	------	-------------------------------------

ER-A5	(NR)	<b>CRD1 error with MP-ENC board</b>
-------	------	-------------------------------------

ER-A6	(NR)	<b>CRS2 error with MP-ENC board</b>
-------	------	-------------------------------------

ER-A7	(NR)	<b>CRD2 error with MP-ENC board</b>
-------	------	-------------------------------------



ER-A8	(NR)	Encoder direction error with MP-ENC board
ER-A9	(NR)	Shaft encoder error
ER-B0	(NR)	Ramp down error
ER-B1	(NR)	CRS CRD actuation error during ramp down learning
ER-C0	(NR)	Release error
ER-C1	(NR)	Main floor error
ER-C2	(NR)	TipoManovra (Manoeuvre type) error
ER-C3	(NR)	Config1 error (gong and light signals)
ER-C4	(NR)	Config2 error (buzzer volume, arrow mode)
ER-C5	(NR)	Display type error
ER-C9	(NR)	Fire access programming logical fault (EN81_72 only)
ER-E0	(NR)	CRS error with MP-ENC board
<i>Resettable ONLY when the system is in inspection mode</i>		
ER-E1	(NR)	CRDB / CRSB MALFUNCTION (bistable ramp down control and top/lowest floor resetting switches)
<i>Resettable ONLY when the system is in inspection mode</i>		
ER-E2	(NR)	CRDB MALFUNCTION (bistable ramp down control and lowest floor resetting switch)
<i>Resettable ONLY when the system is in inspection mode</i>		
ER-E3	(NR)	CRSB MALFUNCTION (bistable ramp down control and top floor resetting switch)
<i>Resettable ONLY when the system is in inspection mode</i>		
ER-E4	(NR)	RIDB MALFUNCTION (bistable lowest floor inspection ramp down switch)
<i>Resettable ONLY when the system is in inspection mode</i>		
ER-E5	(NR)	RISB MALFUNCTION (bistable ramp down and top floor inspection switch)
<i>Resettable ONLY when the system is in inspection mode</i>		
ER-E6	(NR)	RIDB STAYS CLOSED WITH CAR AT LOWEST FLOOR (bistable lowest floor inspection ramp down switch)
<i>Resettable ONLY when the system is in inspection mode</i>		



# 6 BOARD FUNCTIONS AND LAYOUT

## 6.1. GENERAL WARNINGS

It is assumed, for the safe use of the board, that the reader of this chapter is already familiar with the contents of heading 2.2 "Safety Warnings".



INSTALLER

## 6.2. NECESSARY CONDITIONS FOR RESPONDING TO A CALL

The board can respond to a call when:

- it is not running and "inspection" manoeuvre.
- It is not overloaded.
- None of its photocells or barriers are obscured.
- It is not in a non-recoverable error mode (see par. 5.2 "Fault table and fault finding").
- It is not in board or timer/variable-function programming mode.
- The following leds are on: OK/WD/D1/D2/D3.

If the above conditions are satisfied, the system responds to the call by closing the doors (REMP2: red led CP/CP1) and, once safety chain closure has been verified (REMP2: led D4), it closes the retiring cam, if present (REMP2: led PAT) and the contactors, in the sequence high speed+up or high speed+down.

The control signals for exciting the drive contactors are output by connector J8 on board MP3, while the red leds light up on the REMP2, depending on the type of actuation:

Actuation	LEDs on REMP2	Terminals	Connectors	Function
Hydraulic	S	1/2	J8	Up
	D	4/3	J8	Down
	GV	5/6	J8	High speed
	PV	8/7	J8	Timer for delay star/delta delay or stop delay at engine switch off
2 Speed	S	1/2	J8	Up
	D	4/3	J8	Down
	GV	5/6	J8	High speed
	PV	8/7	J8	Low speed
1 Speed	S	1/2	J8	Up
	D	4/3	J8	Down
	GV	5/6	J8	High speed / power contactor (P)
Variable Frequency Drive	S	1/2	J8	Up
	D	4/3	J8	Down
	GV	5/6	J8	High speed (run)
	PV	8/7	J8	Low speed

## 6.3. INSULATION TEST



### IMPORTANT

*During electrical insulation test all sockets must be removed from MP3 microprocessor board.*

Further informations on the procedure are stated on the control panel specific wiring diagram.

## 6.4. SAFETY CHAIN STATUS CHECK POINTS

The MP3 board checks the safety chain status through 4 pick-up points identified by 4 LEDs on REMP2:

Pick-up no.	LEDs on REMP2	Connector / terminal	Controller contacts
1	D1	J7/4	<ul style="list-style-type: none"> <li>• Car top stop button</li> <li>• Car stop</li> <li>• Pit stop</li> <li>• Car safety gear</li> <li>• Car speed governor</li> <li>• Car speed governor tensioner</li> <li>• Counterweight speed governor</li> <li>• Counterweight speed governor tensioner</li> <li>• Pit buffers</li> <li>• Car top emergency trap</li> </ul>
2	D2	J7/6	<ul style="list-style-type: none"> <li>• Limit switch (overtravel)</li> </ul>
3	D3	J7/8	<ul style="list-style-type: none"> <li>• Manual car door</li> <li>• Auxiliary manual swing landing doors</li> </ul>
4	D4	J7/10	<ul style="list-style-type: none"> <li>• Automatic car door (gate)</li> <li>• Automatic landing door locks (without retiring cam).</li> </ul>



### IMPORTANT

*With retiring cam installed, the lock's switches of manual and automatic landing doors must be wired after the 4st pick-up point (D4).*



### IMPORTANT

*For the contacts, refer to the system's wiring diagram.*

## 6.5. SWITCH FUNCTIONS

### 6.5.1. UM/DM REED

With only two contacts (UM / DM), in combination with four magnetic strips per floor, the following functions are available:

- Floor count (UM for up and DM for down travel)
- Start of slowdown (stop for 1 speed systems)
- Stop (both UM and DM are present)
- Doors zone (both UM and DM are present)

**It is possible to cross the slowdown strips if the slowdown distance is greater than half the floor spacing.**



### 6.5.2. RZA / RZB REED SWITCH CONTACTS

The two reed switch contacts (RZA / RZB) are contained in the same housing and, in combination with a single magnetic strip per floor, actuate the safety circuit which defines and enables:

- Hydraulic: the releveling zone
- Rope: the door pre-open and/or releveling zone.

The safety circuit employs three contactors K1, K2, K3.

### 6.5.3. DMS / DMD REED SWITCH CONTACTS

The DMS and DMD reed switches are used for the "short floor" function, i.e. when the space between two floors is less than the slowdown distance + 400 mm.

The DMS reed switch (up) and DMD reed switch (down) enable:

- If there is insufficient physical space to slowdown between the two floors, they initiate slowdown before the floor immediately preceding the destination floor
- They move the car in low speed between the two closely spaced floors

Depending on the order data, the wiring diagrams normally include an enclosure indicating how to lay out the additional magnetic strips for the "short floors".

### 6.5.4. SLOWDOWN / PHASE PLUG CONTROL AT THE TOP AND LOWEST FLOORS (CRS / CRD)

Both electromechanical contacts **CRS/CRD** (or **CRSB/CRDB** bistable without/with supporting relay), located at the end floors, act directly on the direction contactor coils to stop the car and prevent it travelling beyond its travel limits at high speed if it arrives "out of step". They therefore have a safety function and reliable contacts should therefore be used, preferably "obligatory disconnect" limit switches.

They must be located at a distance such that, once they are tripped, the car will stop under friction in worst case loading (empty when travelling up and fully loaded when travelling down) before it reaches the end floor.

In addition to its slowdown control function, the CRD acts as a phase plug at the lowest floor (see par. 3.3 "Reset").

## 6.6. BOARD TECHNICAL SPECIFICATIONS

### 6.6.1. MP3 BASE BOARD

**MP3SW**

This is the motherboard, located in the control cabinet, responsible for serial communications, via inputs J3/2-3, with the car and floor serial boards.

### 6.6.2. MPCAB SERIAL BOARD

**MPCAB**

Located on the car roof, it handles the serial connection between the cabinet and car relating to:

- no stop / mobile pit
- photocells / safety edges
- door operators (optional) and their limit switches
- gong / overload signal



#### **IMPORTANT**

*The maximum number of available stops is 32*



### 6.6.3. SERIAL BOARDS IN THE CAR AND AT THE FLOOR LANDINGS

<b>FLSER</b>	Handles the call buttons, signals and special manoeuvres
<b>FLDISP</b>	Handles the position and direction indicators
<b>DSPCOM</b>	Handles the serial position and direction indicators



#### **IMPORTANT**

*The maximum number of available stops is 32*

### 6.6.4. ACF BOARD

Has the following functions:

- 24 V DC power supply (it transforms the 18 VAC arriving from the transformer).
- Phase sampling (it transforms the mains voltage into two low voltage signals sent to terminals J2/2 and J2/3 used by the board to monitor the phases).

**6 Amperes** | For Simplex systems with more than 12 stops and Duplex / Triplex / Quadruplex systems





### 6.7. MP3 BOARD LAY-OUT

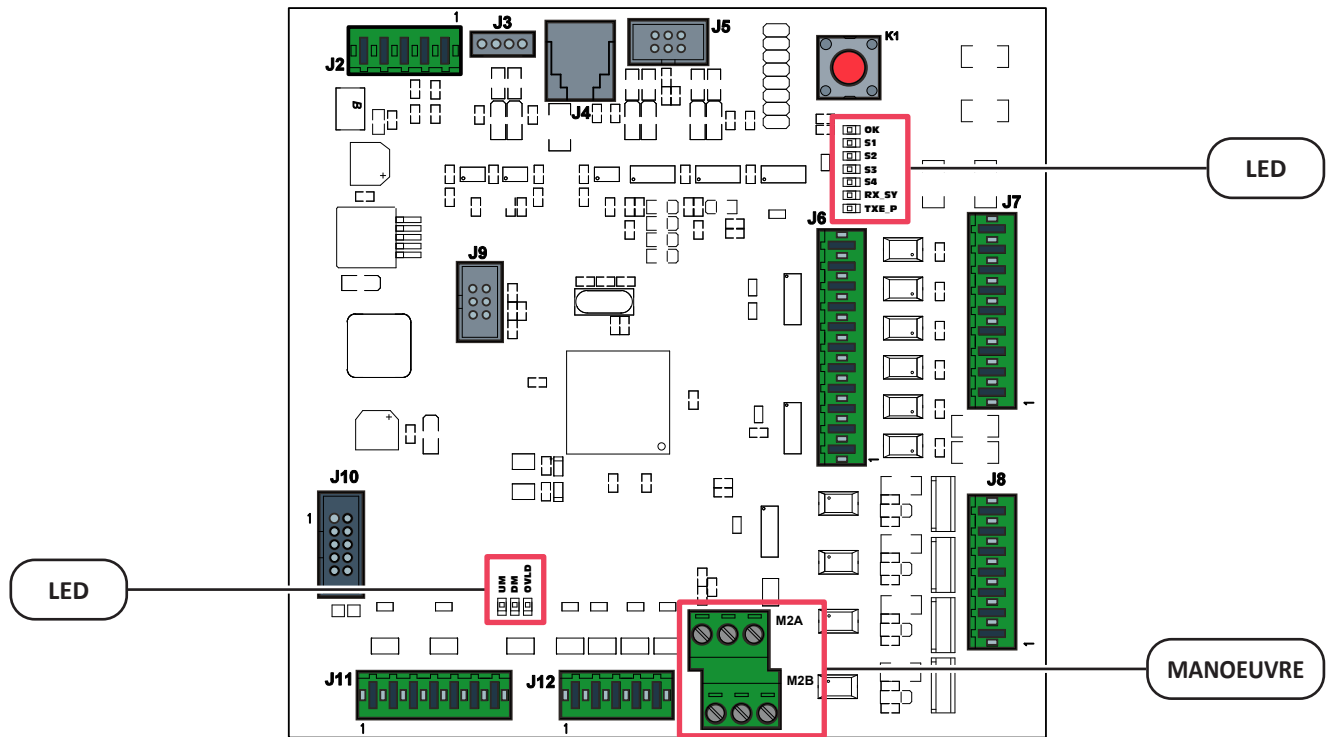

#### 6.7.1. LED ON MP3 BOARD

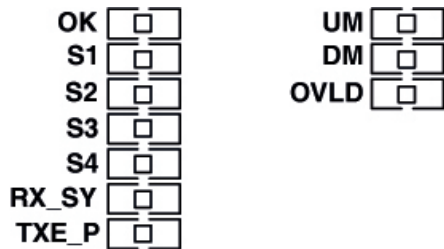

Led	Indication		Description
	output/ and	Input	
OK			board/program active indication
S1			
S2			
S3			
S4			
RX			
TXE			
UM		M2A/2	UM reed switch: up travel
DM		M2A/3	DM reed switch: down travel
OVLD		M2B/3	overload / overtemperature in the machine room



## 6.8. MPCAB BOARD LAY-OUT

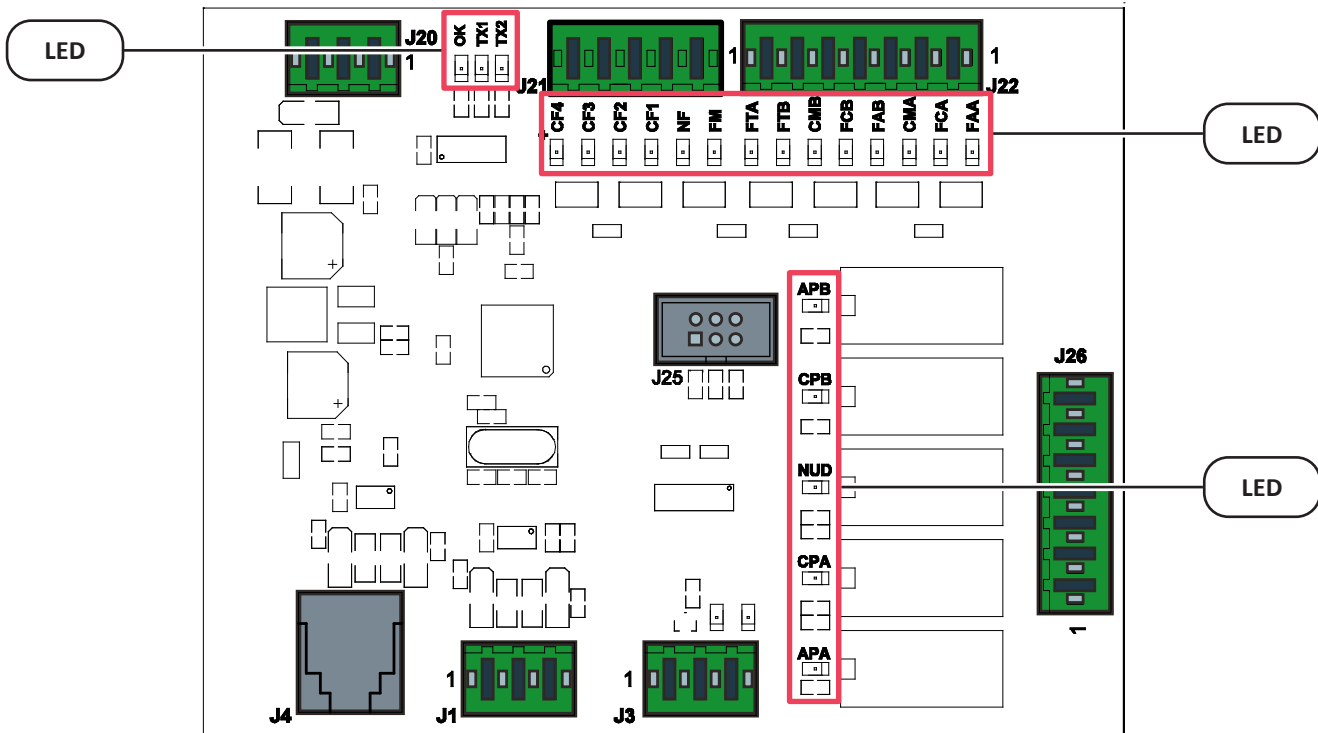

### 6.8.1. LEDs ON MPCAB BOARD

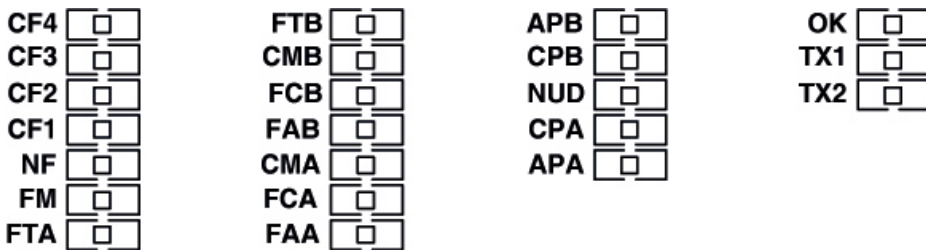

Led	Indication		Description
	output/ and	Input	
CF4			Programmable input
CF3			Programmable input
CF2			programmable input / NO auxiliary contact for side B car doors
CF1			programmable input / NO auxiliary contact for side A car doors
NF		J21/2	no stop (80 %) NO
FM		J21/1	mobile pit NO/load 1 passenger NO
FTA		J22/8	front photocell / electronic barrier side A NC
FTB		J22/7	rear photocell / electronic barrier side B NC
CMB		J22/6	rear operator mobile rib / side B NC
FCB		J22/5	rear operator closure limit switch / side B NC
FAB		J22/4	rear operator opening limit switch / side B NC
CMA		J22/3	rear operator mobile rib / side A NC
FCA		J22/2	front operator closure limit switch / side A NC
FAA		J22/1	front operator opening limit switch / side A NC



Led	Indication		Description
	output/ and	Input	
APB		J26/5	rear door opening / Side B NC
CPB		J26/7	rear door closure / Side B NC
NUD			
CPA		J26/3	front door closure command / side A
APA		J26/1	front door opening / side A
OK			board / program active indication
TX1			serial communications
TX2			serial communications

### 6.9. FLSEER BOARD LAY-OUT

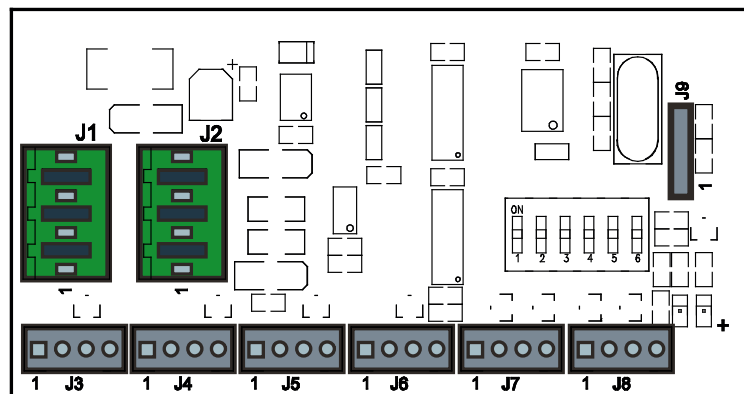

### 6.10. FLDISP BOARD LAY-OUT

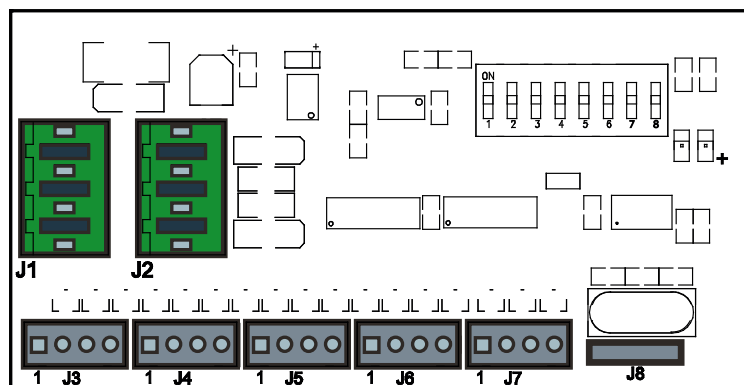

### 6.11. DSPCOM BOARD LAY-OUT

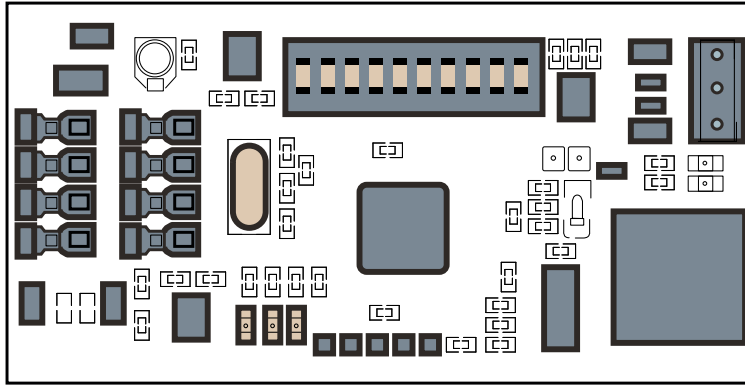

### 6.12. REMP2 LAYOUT

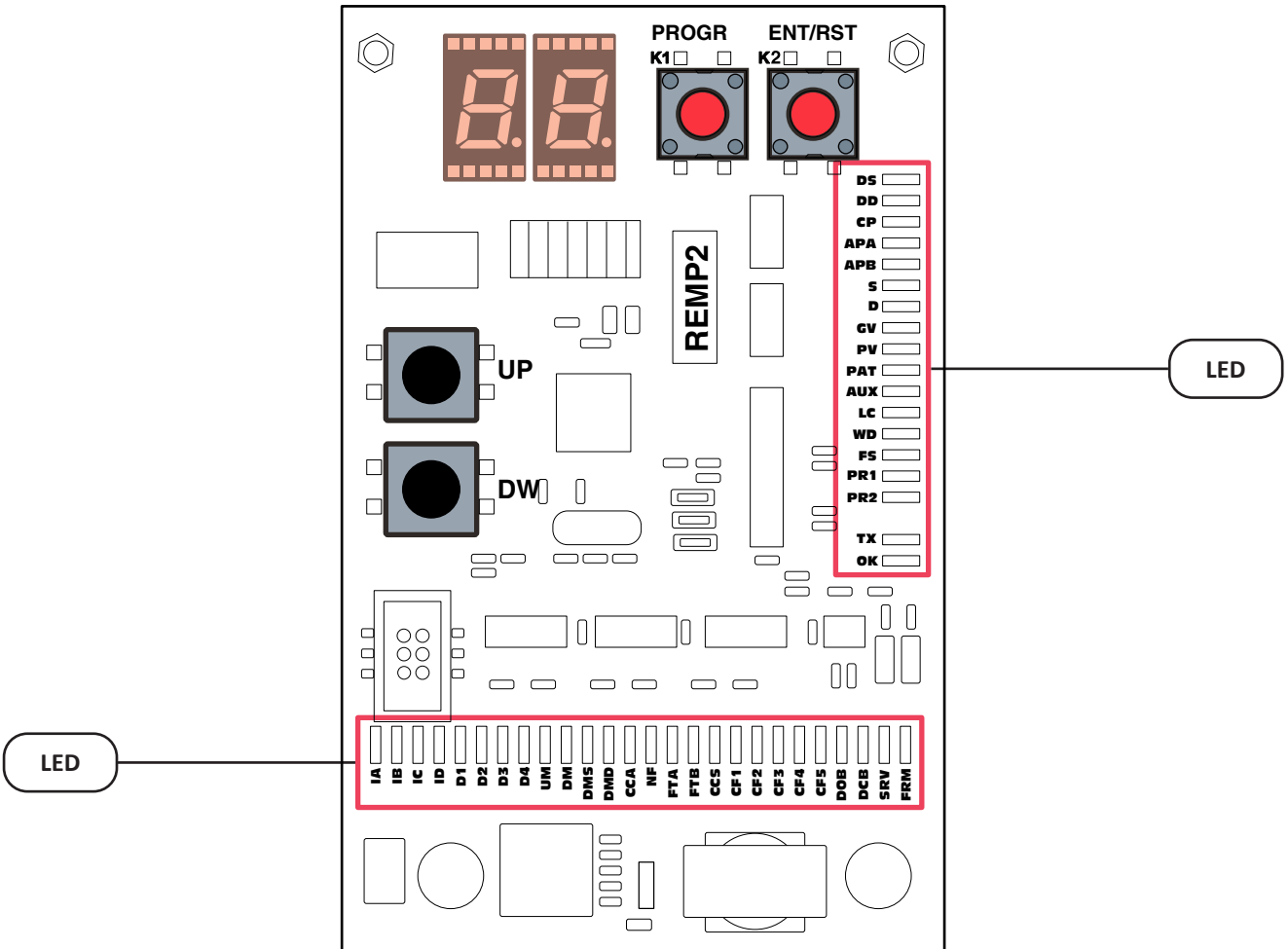



## 6.12.1. LEDs ON REMP2

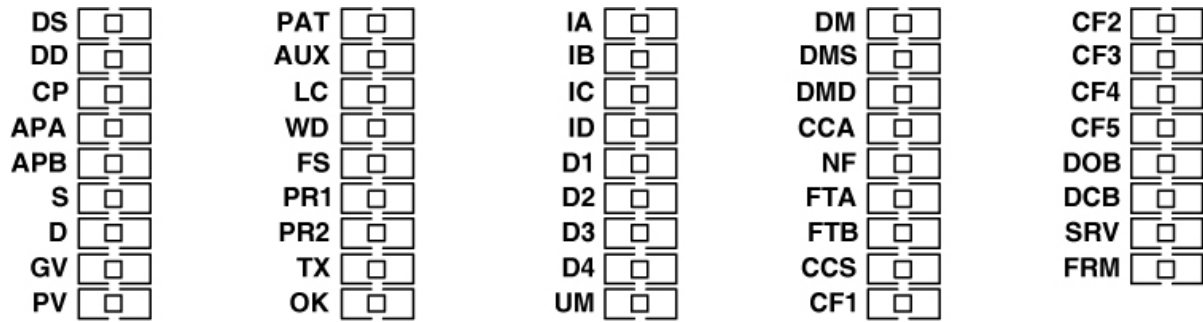

Led	Indication		Description
	output/ and	Input	
DS			up direction
DD			down direction
CP	J6/10		Front side doors closing command
APA	J6/9		Front side doors opening command
APB	J6/8		Rear side doors opening command
S	J8/1 > J8/2		up control signal
D	J8/4 > J8/3		down control signal
GV	J8/5 > J8/6		GV control signal (high speed)
PV	J8/8 > J8/7		PV control signal (low speed)/hydraulics timer with star/delta starting or 2 second stop delay
PAT	J6/7		retiring cam control signal
AUX	J6/6		travel between consecutive floors control signal
LC	J6/5		car light control signal
WD	J6/4		hydraulic: manoeuvre disable/protection control signal
FS			out of service control signal
PR1	J6/2		Rear side door closure command / Side "B"
PR2			Programmable command
TX			
OK			board/program active indication
IA		J11/1	high speed (GV) and low speed (PV) contactor controls signal
IB		J11/2	up (S) and down (D) contactor control signal
IC		J11/3	front door movement control signal
ID		J11/4	rear door movement control signal
D1		J7/4	Safety chain 1st check
D2		J7/6	Safety chain 2nd check
D3		J7/8	Safety chain 3rd check
D4		J7/10	Safety chain 4th check
UM		M2A/2	UM reed switch: up travel
DM		M2A/3	DM reed switch: down travel
DMS		J11/7	DMS reed switch: up travel minimum distance
DMD		J11/8	DMD reed switch: down travel minimum distance
FM		J21/1	mobile pit / 1 passenger present in car
NF		J21/2	no stop (80%)

Led	Indication		Description
	output/ and	Input	
FTA			
FTB			
CCS		J11/5	hydraulic: safety circuit/variable speed drive: power contactors (TL1, TL2)
CF1		J12/4	programmable input / enable emergency manoeuvre
CF2		J12/5	Programmable input
CF3		J12/6	Programmable input
CF4		J12/2	programmable input / down travel leveling control signal
CF5		J12/3	programmable input / up travel leveling control signal
DOB			open doors button
DCB			close doors button
SRV			reserve car manoeuvre
FRM		J12/1	fire services manoeuvre

## 6.13. MANOEUVRES

The following basic manoeuvres are provided:

- Universal
- Simplex collective down
- Simplex collective complete (up and down)
- Duplex collective down
- Duplex collective complete (up and down)
- Triplex collective down
- Triplex collective complete (up and down)
- Duplo
- Car: universal. Floors: reserve in order of call
- Car: reserve. Floors: universal
- Duplo - universal manoeuvre with interdiction of simultaneous call between two lifts
- Duplo - universal manoeuvre with interdiction of simultaneous call between two lifts and arrival of the nearest car

Different or special manoeuvres can be implemented on request.

## 6.14. CONNECTIONS FOR DUPLO/DUPLEX/TRIPLEX/QUADRUPLEX MANOEUVRES

Duplo / Duplex / Triplex / Quadruplex manoeuvre cabinets are identical to each other and differ from Simplex cabinets in the use of the DPXT board and the presence of the +24D terminal (floor reservation common).



### IMPORTANT

The tests are detailed in Par. 7 "System Tests" in the **Manual** for the system in question.